



# CONCRETE-TO- CONCRETE CONNECTIONS

Using Post-installed Systems



Handbook, ver. 01  
January, 2024



# TABLE OF CONTENTS

<b>Foreword</b>	<b>6</b>
<b>1. Introduction</b>	<b>7</b>
<b>2. Applications &amp; basic mechanisms</b>	
<b>2.1 Applications</b>	<b>8</b>
2.1.1 Post-installed rebars: what are they?	8
2.1.2 Classification of applications with post-installed rebars	9
2.1.3 Lap splice applications for member extensions	9
2.1.4 Structural connections using end anchorages	9
2.1.5 Concrete shear-friction applications (overlays) using shear connectors	10
<b>2.2 Load bearing mechanisms</b>	<b>12</b>
2.2.1 Load-bearing mechanism for lap splices and end anchorages	12
2.2.2 Load-bearing mechanism for shear-friction applications	16
<b>3. Regulatory framework for qualification &amp; design</b>	
<b>3.1 Overview of the European regulatory framework</b>	<b>18</b>
<b>3.2 Design of post-installed rebar applications</b>	<b>19</b>
3.2.1 Eurocode design provisions	19
3.2.2 Applications covered by EC2-1-1 design provisions	20
3.2.3 EOTA TR 069 provisions and covered applications	20
<b>3.3 Assessment of post-installed rebar systems</b>	<b>21</b>
3.3.1 EAD 330087 (Assessment of post-installed rebar suiting EC2-1-1 design provisions)	21
3.3.2 EAD 332402 (Assessment of post-installed rebar suiting EOTA TR 069 design provisions)	23
<b>3.4 Design of post-installed shear-friction (overlays) applications</b>	<b>24</b>
3.4.1 EC2-1-1 design provisions	24
3.4.2 EOTA TR 066 design provisions	24
<b>3.5 Assessment of post-installed shear connector systems</b>	<b>25</b>
3.5.1 EAD 332347 assessment	25
<b>3.6 Summary</b>	<b>26</b>
<b>3.7 Reinforced concrete material</b>	<b>27</b>
3.7.1 Concrete and its required properties	27
3.7.2 Rebar and its required properties	27
<b>4. Hilti solutions</b>	
<b>4.1 Solutions for post-installed rebar applications</b>	<b>28</b>
<b>4.2 Solutions for post-installed shear friction (overlay) applications</b>	<b>29</b>

<b>4.3</b>	Design and execution process steps	29
<b>4.4</b>	Hilti as total system solution provider	30
<b>5.</b>	<b>Design of lap splices</b>	
<b>5.1</b>	General	32
<b>5.2</b>	Design for static actions	32
5.2.1	Detailing rules	35
5.2.2	Durability requirements	36
<b>5.3</b>	Design for seismic actions	36
<b>5.4</b>	Design for fire exposure	37
5.4.1	Basic verification	38
5.4.2	Design splice length calculation	38
5.4.3	Steel failure verification	39
5.4.4	Simulation approach for reduction factors	39
<b>5.5</b>	Design example of lap splice connection	40
<b>6.</b>	<b>Design of end anchorages</b>	
<b>6.1</b>	General	46
<b>6.2</b>	Basic anchorage length according to EC2-1-1	46
6.2.1	Design for simply supported connections	47
<b>6.3</b>	Design for rigid/moment-resisting connections	48
6.3.1	Strut-and-tie model following the principles of Eurocode	48
6.3.2	EOTA TR 069 design provisions	51
6.3.3	Design according to EC2-1-1 principles with improved bond strength (Hilti method)	57
<b>6.4</b>	Design for seismic load actions	58
6.4.1	Design for seismic load actions as per Eurocode	58
6.4.2	Design for seismic load actions as per EOTA TR 069	58
<b>6.5</b>	Design for fire exposure	59
<b>6.6</b>	Design examples	61
6.6.1	Simply supported connection	61
6.6.2	Design example of end anchorage with strut-and-tie model	64
6.6.3	Design example of end anchorage with EOTA TR 069	69
<b>7.</b>	<b>Design of shear-friction (overlay) applications</b>	
<b>7.1</b>	Interface shear transfer & shear-friction theories	73
7.1.1	Design of shear interface according to EC2-1-1 provisions (for predominant shear)	74
7.1.2	Design of shear interface when loading is not predominant shear	76
<b>7.2</b>	Design of shear-friction applications (overlays) – static	77
7.2.1	Design of shear interface according to EC2-1-1 provisions	77
7.2.2	Design of shear-friction applications (overlays) as per EOTA TR 066	77

7.2.3	Additional detailing rules for shear connectors as per EOTA TR 066	81
<b>7.3</b>	<b>Design of concrete shear-friction applications (overlays) – Fatigue</b>	<b>82</b>
7.3.1	Design as per EC2-1-1	82
7.3.2	Design as per EOTA TR 066	82
<b>7.4</b>	<b>Design of concrete shear-friction applications (overlays) – Seismic</b>	<b>84</b>
7.4.1	Design as per EOTA TR 066	84
<b>7.5</b>	<b>Design of shear-friction applications (overlays) as per Hilti method</b>	<b>85</b>
7.5.1	Design as per Hilti method - Static	85
7.5.2	Design as per Hilti method - Seismic	86
<b>7.6</b>	<b>Design examples</b>	<b>87</b>
7.6.1	Interface shear transfer in moment-dominated connection	87
7.6.2	Interface shear transfer in compression/shear dominated connection	88
7.6.3	Overlay – static design example	89
7.6.4	Overlay – fatigue design example	91
7.6.5	Overlay – seismic example	92
7.6.6	Overlay – Hilti method example	93
<b>8.</b>	<b>PROFIS Engineering suite - software design</b>	
<b>8.1</b>	<b>Introduction</b>	<b>95</b>
<b>8.2</b>	<b>Why use PROFIS Engineering Suite?</b>	<b>95</b>
<b>8.3</b>	<b>Designing post-installed rebar applications using PROFIS</b>	<b>96</b>
8.3.1	Additional important features in PROFIS	99
<b>8.4</b>	<b>Designing shear-friction (overlay) applications using PROFIS</b>	<b>100</b>
<b>9.</b>	<b>Installation and inspection</b>	
<b>9.1</b>	<b>Post-installed rebar installation procedure</b>	<b>102</b>
9.1.1	Post-installed rebar positioning	102
9.1.2	Surface preparation/roughening	103
9.1.3	Drilling of holes in concrete	104
9.1.4	Roughening of drilled (bore) holes	106
9.1.5	Cleaning of drilled holes	106
9.1.6	Injection of adhesive mortar and rebar installation	107
9.1.7	Hilti SafeSet™ system	109
<b>9.2</b>	<b>Post-Installed shear connectors installation procedure</b>	<b>111</b>
9.2.1	Construction requirements for post-installed shear connectors as per EOTA TR 066	112
<b>9.3</b>	<b>Inspection, testing &amp; quality control</b>	<b>112</b>
<b>9.4</b>	<b>Additional construction/installation aspects</b>	<b>115</b>
9.4.1	Concrete sensors for on-site monitoring	115
<b>9.5</b>	<b>Construction specifications</b>	<b>116</b>



<b>9.6</b>	Hilti for engineering support	<b>117</b>
<hr/>		
<b>10.</b>	<b>Reference projects</b>	
<hr/>		
<b>10.1</b>	Nathani Heights, Mumbai, India	<b>118</b>
<b>10.2</b>	School seismic strengthening, Bologna, Italy	<b>120</b>
<b>10.3</b>	The Exchange 106, Kuala Lumpur, Malaysia	<b>122</b>
<b>10.4</b>	Schott Solar Jena AXL 33, Germany	<b>124</b>
<b>10.5</b>	Renovation of the Humboldt Bridge in Potsdam, Germany	<b>125</b>
<hr/>		
<b>Authors</b>		<b>127</b>
<hr/>		
<b>Acknowledgement</b>		<b>127</b>
<hr/>		
<b>References</b>		<b>128</b>
<hr/>		

## FOREWORD

by

**Elizabeth Vintzileou**

**Professor Emeritus, National Technical University of Athens, Greece**



Ageing and decay, adverse environmental conditions, change of use, adoption of new design codes, occurrence of accidental actions (e.g., fire, earthquake, etc.) and their effects on existing structures are some of the cases that make interventions necessary. The development of materials and techniques to make structures once again adequate for use is an important field of research, design and in situ application.

The structural engineer, whose responsibility is to assess the structure, to select the most appropriate techniques and to design the structure in its final form, also must provide the design and the structural detailing of critical areas requiring specific knowledge and expertise. These include, for example, the areas of anchoring new reinforcement or providing adequate lap length to reinforcing bars, the reinforced interfaces between new and existing structural members or within a strengthened structural element, etc. Those areas, of limited volume and quite often of limited accessibility, are critical for the success of the intervention, in terms of safety, durability and indeed of economy.

In this field, the strategic initiative of Hilti to provide not only high-quality products and tools and related services to the designer, but also integrated solutions is highly appreciated by the engineering community. PROFIS Engineering software is a valuable tool developed to assist structural engineers in the design of numerous applications and, more specifically, of the critical areas where interfaces crossed by post-installed reinforcing bars and anchors occur. This handbook can be considered as a useful guide for effective use of PROFIS Engineering software. Nonetheless, its scope is multiple, and its value goes far beyond the design of connections where Hilti products are used.

Indeed, this handbook offers the description of applications, including illustrative examples, where the use of post-installed reinforcing bars and anchors is needed to connect concrete elements cast at different times, along with the mechanics of transfer of forces between the anchors and the concrete. Thus, the engineer is assisted in the effort to select the intervention and its location, based on its relevance to the examined case.

The European regulatory environment related not only to the system of Eurocodes, but also to the assessment of post-installed systems, within the European Organization for Technical Approvals is presented and discussed. This is of significance, as the designer gets acquainted with the decisive parameters that are assessed for each post-installed system, with the limitations of use of each specific system, as well as with the design of applications implying the use of post-installed reinforcement. Based on this framework, this handbook provides the designer with relevant data on the Hilti products, their properties, their field of application and their respective approvals.

One of the most significant contributions of this handbook is that it provides for each treated application code provisions and limitations, equations applied in calculations, options given to the engineer in terms of geometry and arrangement of anchors, range of base material, etc. Thus, the engineer is given the necessary instruments to explore alternative solutions, select various materials and check the effect of different parameters to reach an optimum result. The quality of the content, the range of the applications covered, the clarity and the completeness of the information included in this handbook make me confident that it is a significant contribution to the design of concrete-to-concrete connections and that the Engineering Community will give it the acceptance it deserves.



# 1. INTRODUCTION

Structures such as buildings, bridges, dams, or other constructions are made primarily of concrete since it is a versatile material that is commonly used in construction due to its strength, durability, and ability to be molded into various shapes. The aging of the building stock as well as the increased awareness of risks related to natural and man-made hazards (e.g., earthquakes and fire) as well as to sustainability requirements are highlighting the need for structural interventions on existing buildings. These interventions usually target structural strengthening and/or functional repurposing. Furthermore, there is an increasing need for construction technology to meet demanding requirements in terms of sustainability, as well as efficiency in terms of productivity and lean constructions. To meet such requirements, concrete members cast at different times often need to be connected or the section of structural elements needs to be increased. Post-installed rebars and shear connectors installed into hardened concrete structures are well-established solutions to ensure safer and more reliable connections between existing and new concrete elements.

Design of cast-in-place reinforced concrete structural systems are well established and documented in the engineering community. The structural behavior and applicable design methods are well understood and implemented around the world through their respective codes and standards. However, understanding and designing post-installed systems for concrete structures reveals the need to grasp new technical concepts and methods to be able to arrive at safe and efficient solutions for both design and installation of such systems.

The world of concrete-to-concrete connections using post-installed rebars or shear connectors has evolved long way. It has gone from using a limiting equivalency load-displacement behavior for cast-in systems to more advanced methods where product-dependent performance paves the way for safer, more reliable and economical design methods. This handbook attempts to compile and render state-of-the-art technical concepts, design methods, calculation examples and tools to help you design and install post-installed systems for concrete structures. We have done this in a concise and user-friendly manner for the Engineering Community.

After [chapter 2](#), which highlights the main applications within the scope of this handbook, [chapter 3](#) explains the framework for assessment and qualification of products which are critical for performance of the designed applications. [Chapter 4](#) talks about the Hilti solutions qualified for various design requirements. [Chapter 5](#), [chapter 6](#) and [chapter 7](#) give the applicable design methods and step-by-step calculations for the design of lap-splices, end-anchorage and shear-friction (overlay) applications, subjected to various loading actions and installation conditions.

[Chapter 8](#) is dedicated to Hilti's PROFIS Engineering software suite, a one-stop tool for designing concrete-to-concrete connections using the illustrated design methods in the most efficient and productive way. [Chapter 9](#) is dedicated to the installation, inspection, and importance of quality control of post-installed systems for concrete structures. This is because the correct execution methods are crucial for realizing the design intent and life of the structures. [Chapter 10](#) comprises of some reference project examples from different parts of the globe, which were made possible by adopting Hilti's post-installed rebar and shear connector solutions.



## 2. APPLICATIONS & BASIC MECHANISMS

### 2.1 Applications

The need for connecting elements cast at different times in reinforced concrete (R.C.) structures with post-installed solutions is a topic of growing relevance worldwide. This need may frequently arise out of **unplanned** situations where the detailing and provisions for dowel/starter rebars or couplers were missed out either in the construction drawings or during actual construction (including misplaced rebars). However, it can also be **planned** in new construction activities to optimize and speed up the workflow (avoiding rebars sticking out of formwork intended as dowel or starter bars). Also, the requirement for such connections is of high relevance in enhancement construction activities like the strengthening/retrofitting of entire building structures or structural members due to functionality changes and/or to meet updated code requirements.

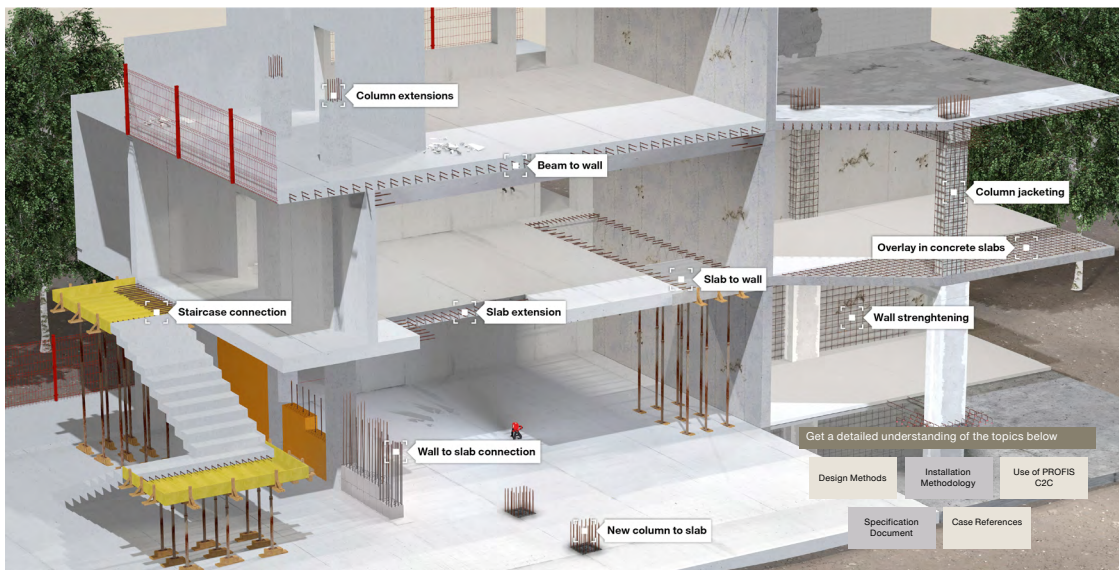

#### 2.1.1 Post-installed rebars: what are they?

A common and long-standing solution involves the installation of rebar in holes drilled in the pre-existing concrete. These are filled with compatible adhesive mortar to emulate the behavior of cast-in-place reinforcing bars to achieve force transfer of the engaged rebar(s) or just to embed the rebar (Fig. 2.1). These items are usually referred to as post-installed reinforcing bars. The rebars may be equipped with hooks or heads on the cast-in end but by necessity have a straight shape at the post-installed end.

Post-installed rebars are typically used to connect concrete structural elements cast at different times to establish a monolithic connection between the existing and new elements (Fig 2.1). They serve as reliable, faster, and economic solutions to establish concrete-to-concrete connections to strengthen or extend existing structures. Key roles are played by the appropriate design methods and selection of adhesive mortar. Furthermore, the installation must be carried out by qualified and experienced professionals.

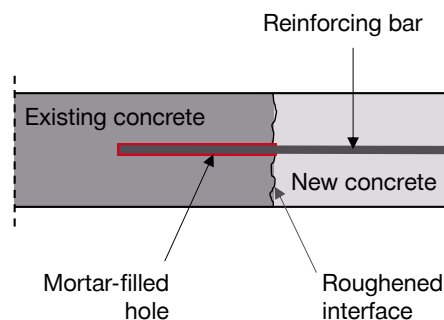

Fig. 2.1: Post-installed rebar system



## 2.1.2 Classification of applications with post-installed rebars

The application range of post-installed rebar system connections can be broadly classified as **lap splice**, **end anchorage** and **shear friction interface (overlay) applications** (refer Fig 2.2). Lap splices and end anchorages are used to establish structural connections where the force transferred is primarily tension/compression (induced either by axial or bending moment action) in the rebars. Hence these connections can be referred to as bending/axial applications using post-installed rebars. Shear friction applications can be established using post-installed rebars or special shear connectors.

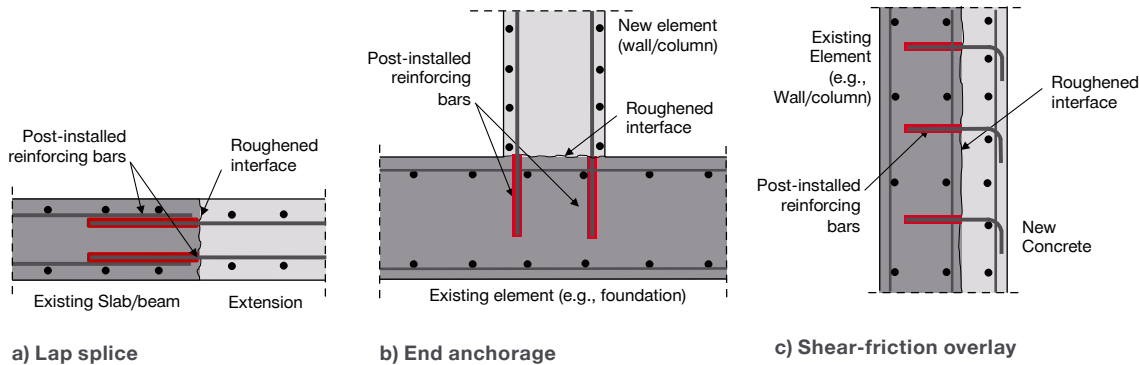

Fig. 2.2: Types of post-installed rebar applications

## 2.1.3 Lap splice applications for member extensions

A construction program at a given work site might require post-installed rebar connections to facilitate extension/continuation of floor slab or vertical elements such as walls and columns, or it might address other structural functional changes. Non-contact lap splices in which axial loads are transferred between adjacent bars are utilized to develop the design resistance of the rebars.

Some examples of extensions of reinforced concrete members with the use of post-installed rebar systems such as slab, beam, column and wall extensions are shown in Fig. 2.3.



Fig. 2.3: Examples of extension of R.C. elements with lap splices using post-installed rebars

## 2.1.4 Structural connections using end anchorages

Post-installed rebars enable the connection of one structural member to another which are usually perpendicular in direction to each other. For example, a column or a wall arising from foundations, a beam/girder getting connected to a column/wall, etc. Post-installed rebars can be utilized where cast-in anchoring rebars were missed out during new construction and are required for connecting pre-cast elements in new construction. They can also be used where protruding rebars are not available in the pre-existing structural members to achieve a lap splice connection.



a) Stair-to-wall connection



b) Slab-to-wall connection

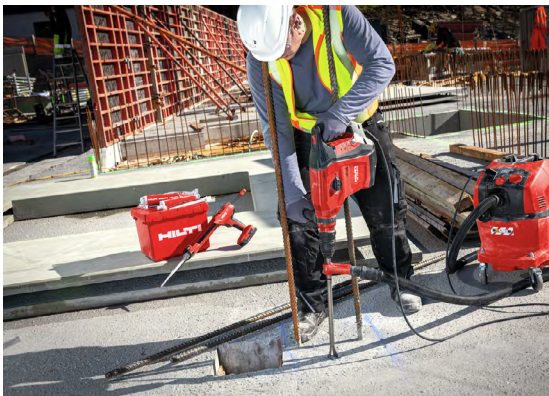

c) Column-to-slab connection



d) Beam-to-column connection

Fig. 2.4: Examples of anchorage connections using post-installed rebar

### 2.1.5 Concrete shear-friction applications (overlays) using shear connectors

Connections between layers of concrete cast at different times can be established by crossing post-installed rebar or other types of shear connectors. The need for this is increasing in strengthening/rehabilitation jobs and there is a growing demand for upgrading existing structural systems. Strengthening/retrofitting generally arises out of the existing structural element due to increased loading dictated by functionality changes, a distressed structure due to corrosion and other external effects, or because it is mandated by the latest code and regulatory specifications.

While post-installed rebar can be used for shear-friction applications (overlays), proprietary shear connectors are developed with specific geometries and materials to provide an optimized performance in thin overlays (usually up to 150-200 mm). Typically, connectors are installed by drilling into an existing layer of concrete and fixing post-installed rebar dowels or shear connectors using suitable tools, qualified products and installation methods. A new concrete layer of the desired thickness is then cast against the existing concrete after a suitable surface preparation (see Fig. 2.5). Within this group of applications, we consider **concrete overlays**, when an additional layer of concrete is added to existing elements, e.g., thickening of slabs, walls or beams (refer Fig. 2.6). In the case of columns, it is more common to consider **jackets** since the new layers of concrete are typically added on all sides of the original section (refer Fig. 2.6h). More generally, we refer to **shear-friction applications** when the main action on the interface between the two concrete layers cast at different times is a shear stress.

Note: Shear-connectors are more efficient than post-installed rebar for thin overlays



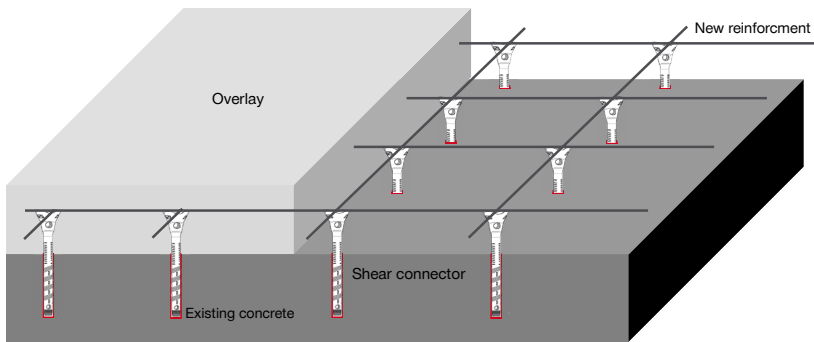
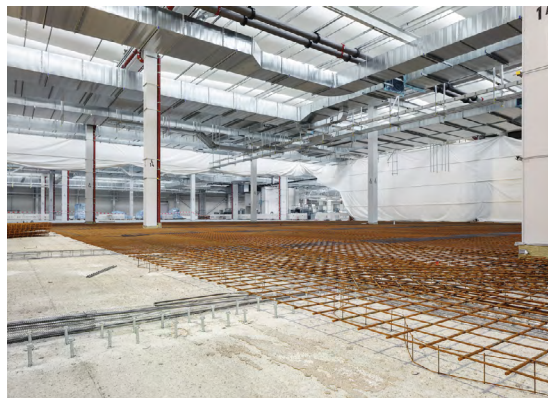

Fig. 2.5: Strengthening/retrofitting of concrete layer using overlay (schematic)



a) Increasing RC beam depth



b) Strengthening of industrial floor



c) Increasing bridge girder thickness



d) Increasing bridge deck slab thickness



e) Shear wall addition



f) Structural wall strengthening



g) Slab shear-friction overlay

h) Column jacketing

Fig. 2.6: Shear friction applications (structural overlays) in buildings &amp; infrastructure

## 2.2 Load bearing mechanisms

The basics of the force transfer mechanism and governing factors of bond strength of post-installed rebar systems are introduced in this section. Note that the post-installed rebar system is similar and comparable to cast-in rebars (CIR) when straight rebars are used and proven in terms of assessment criteria, validated by extensive experimental test results (refer to [chapter 3](#) for more information on assessments of post-installed rebar systems).

### 2.2.1 Load-bearing mechanism for lap splices and end anchorages

Bond is the term commonly used to define the force transfer between rebar (post-installed or cast-in) and surrounding concrete when the rebar is loaded by axial force (tension/compression). The force transfer occurs over the length of the established bond length in a non-uniform pattern over the surface area of the rebar (refer Fig. 2.7). However, a constant bond strength averaged over the entire bond length is usually assumed (uniform bond model) for the design of both post-installed or cast-in rebar systems.

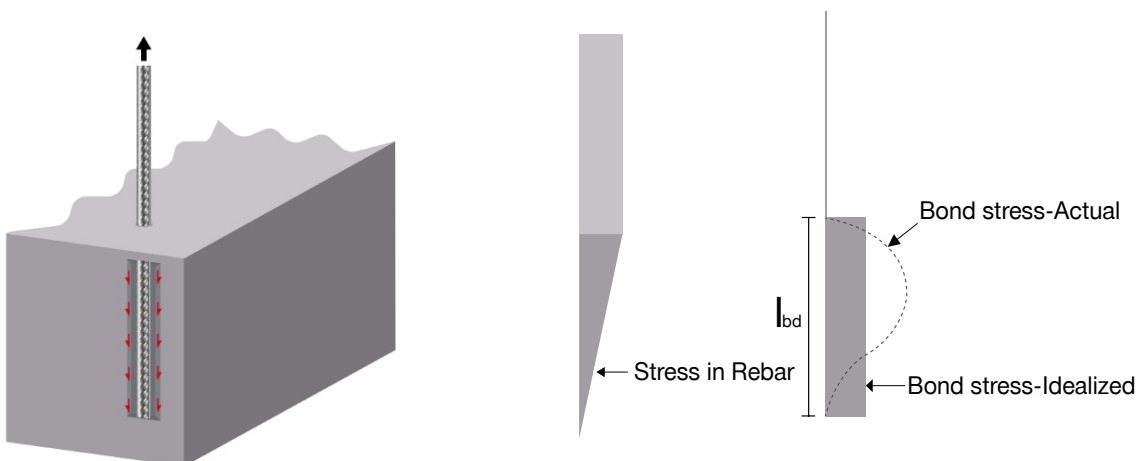

Fig. 2.7: Variation in bond stresses over the bonded length of the axially loaded rebar

The transfer mechanism primarily relies on the mechanical bearing of the ribs present on the surface of rebars against the surrounding mortar when the rebar is engaged in axial load. This creates compression struts radiating at an angle from the ribs called bond stresses which leads to hoop stresses (bursting forces) perpendicular to the axis of the rebar. When these hoop stresses exceed the tensile capacity of the surrounding concrete, splitting, cracking and subsequent failure of cover concrete occurs. We refer in this case to a **bond-splitting failure** (refer Fig. 2.8). Bond-splitting failure mode usually occurs when limited passive confinement is available (usually lesser than  $3\phi$  concrete cover or closely spaced rebars).

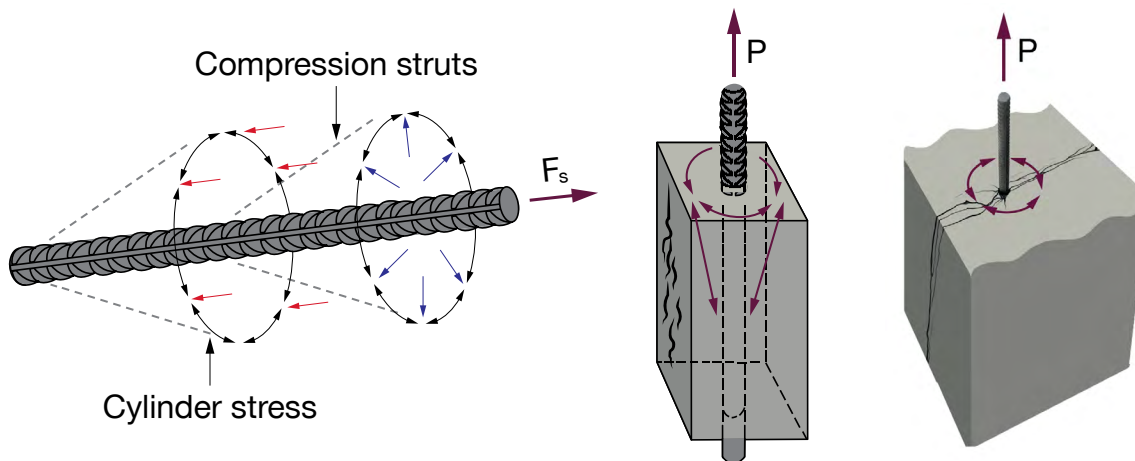

Fig. 2.8: Stress field of bond-splitting failure in an axially loaded rebar

When sufficient concrete cover and/or spacing is present, it provides enough passive confinement so that the rebar shears off at the interface of surrounding mortar without significant damage to the concrete substrate (at higher load levels). In such cases the tensile splitting capacity of concrete is not reached. This is called a **pullout failure** (Fig. 2.9a). The third failure mode is the **yielding of the steel rebar**. Due to its ductility, it is recognized as the preferable failure mode by the state-of-the-art building codes (Fig. 2.9b).

Note that the passive confinement of surrounding concrete can also be achieved by providing sufficient transverse reinforcement crossing across the splitting failure planes. Active confinement can also exist where there are transverse compressive stresses to delay the onset of bond-splitting failure mode.

It is important to remind that the bond mechanism is slightly different when the loaded rebars are cast-in-place or post-installed rebar. In cast-in systems, the rebar (and its ribs) is primarily surrounded by concrete. In this case, there is only one interface within the bonded length: the rebar-concrete interface. However, in a post-installed rebar system, there are two interfaces within the bonded length: rebar-adhesive mortar interface and adhesive mortar-concrete interface (refer Fig. 2.10). Therefore, the bond resistance of post-installed rebar system can be inferior or superior to cast-in rebar system depending on the performance of the mortar and its sensitivity to loading and environmental conditions (refer [chapter 3](#)).

Note: The performance of post-installed rebars is product dependent.



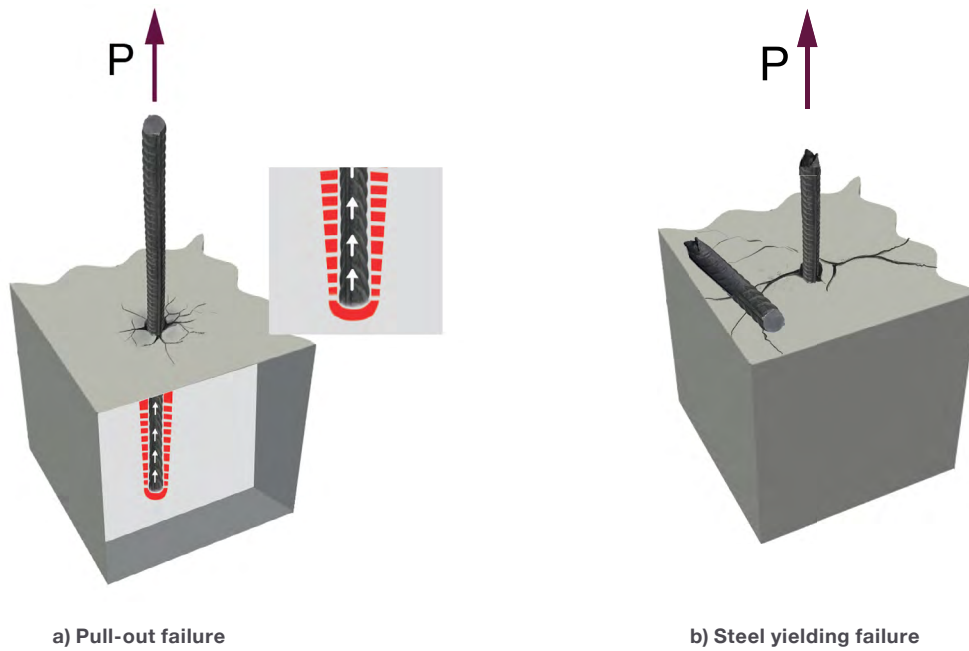

Fig. 2.9: Failure modes of post-installed rebar

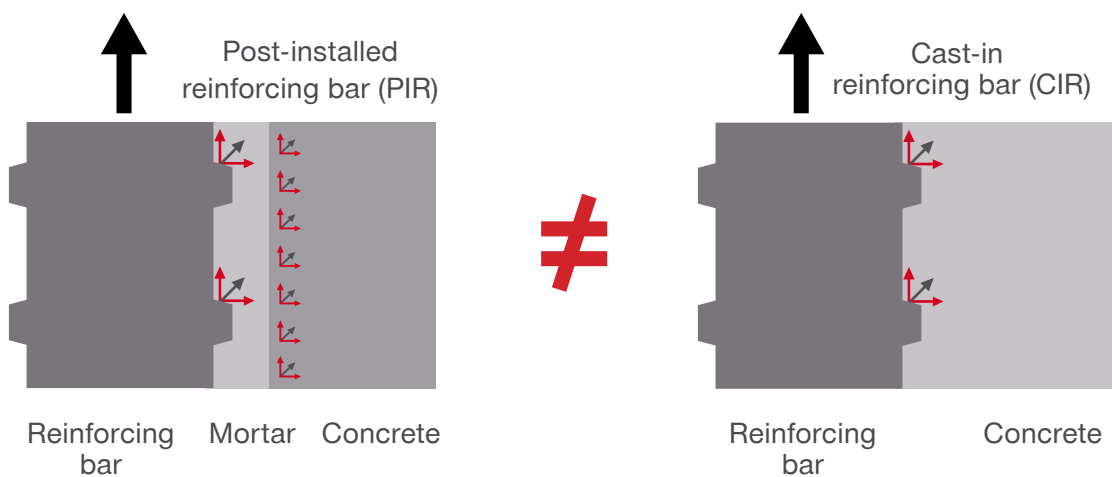

Fig. 2.10: Basic load transfer mechanism of (a) post-installed rebar and (b) cast-in place rebar at the rebar-mortar interfaces

In addition to the mentioned bond-related failure modes of axially tension loaded rebars, there are instances where active confinement is absent, i.e., in the absence of global/local compressive struts. In such cases the anchoring zone of the concrete element might fail through **concrete cone breakout** (refer Fig. 2.11). This failure mode is brittle in nature and, therefore, EC2-1-1 [1] design philosophy avoids it by requiring anchoring of rebars in confined zones. Other design approaches, e.g., EOTA Technical Report (TR) 069 [2] include provisions to check the resistance associated with this failure mode for post-installed rebar systems in cases where the assumption of confined concrete cannot be ensured. This approach is based on **Anchor Theory** as opposed to **Rebar Theory**. The main differences between the two theory/design approaches are summarized in Table 2.1.



Fig. 2.11: Concrete cone breakout failure

Note: Eurocode EN 1992-1-1 shall be referred to as EC2-1-1 throughout this handbook.

Table 2.1: Differences between Rebar Theory &amp; Anchor Theory

Parameter	Rebar Theory	Anchor Theory
Loading direction	Axial compression/tension	Axial compression/tension, shear and combined*)
Load transfer	Utilizes confinement through equilibrium with local/global struts	Utilizes concrete tensile strength assuming no active confinement
Failure modes	Steel yielding, pull out, bond splitting	Steel yielding, pull out, bond splitting, concrete cone breakout
Minimum concrete cover	Dictated by EC2-1-1	Dictated by product assessment
Design standard	EC2-1-1	EOTA TR 069

\*) Note: Rebar anchorages design according to EOTA TR 069 [2] does not consider shear forces acting on the rebars as EC2-4 [3] but applies the same approach of EC2-1-1 [1] for the transfer of shear forces.

The load bearing mechanism for anchorages is different from lap splices, where tension and compression forces are transferred directly to the lapping bar via local struts (see Fig. 2.12a). In anchorages, particular attention must be given to the transfer of tension forces in the existing concrete member. Typically, end anchorage connections are designed to transfer axial tension and compression forces (either decoupled from the applicable bending moment or direct axial forces) through global strut-and-tie models (see Fig. 2.12b). In this way, no direct tension is assumed to be induced in the concrete. In situations where the recommended stable strut-and-tie model cannot be ensured (e.g., predominant tension loading), the potential limiting concrete breakout failure should be checked in addition to the bond and steel yielding failure modes (see Fig. 2.12c).

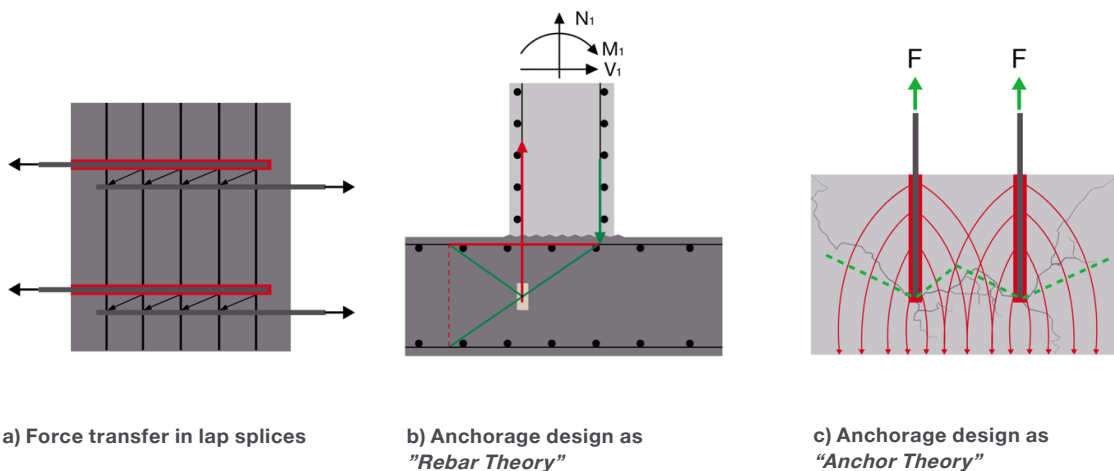

Fig. 2.12: Load-bearing mechanisms

Typically, shear transfer at the interface of existing and new concrete needs to be checked against the shear capacity of concrete as per the design provisions in the applicable design standards. This is because the post-installed rebars are usually not designed to directly resist shear loading in the manner of an anchor bolt, e.g., following the provisions of EC2-4 [3]. However, post-installed rebars can also be used for shear transfer following the mechanical principles of interface shear-friction as explained in the following section and as included in state-of-the-art standards and guidelines (e.g., EC2-1-1 [1] and EOTA TR 066 [4]).

## 2.2.2 Load-bearing mechanism for shear-friction applications

It is critical to ensure the activation of transfer of longitudinal shear stresses through the shear connectors to establish a composite cross-section. This ensures the full structural resistance of the increased cross-section using overlays. If the interface is not connected by shear connectors/dowels, even at the service loads, the adhesive resistance between the two layers is exceeded already at minor deformations of 0.03 to 0.05 mm due to cracking/delamination along the interface, which causes individual flexural bending of the two layers to behave independently rather than monolithically (see Fig. 2.13a and Fig. 2.13b). In this case, the new overlay essentially behaves only as a dead load rather than contributing to combined structural resistance. To ensure a safer, more reliable, and design-intended connection between two concrete layers, the shear transfer needs to be resisted through three main mechanisms (see Fig. 2.14a):

- Adhesion/interlocking
- Friction, and
- Dowel effect

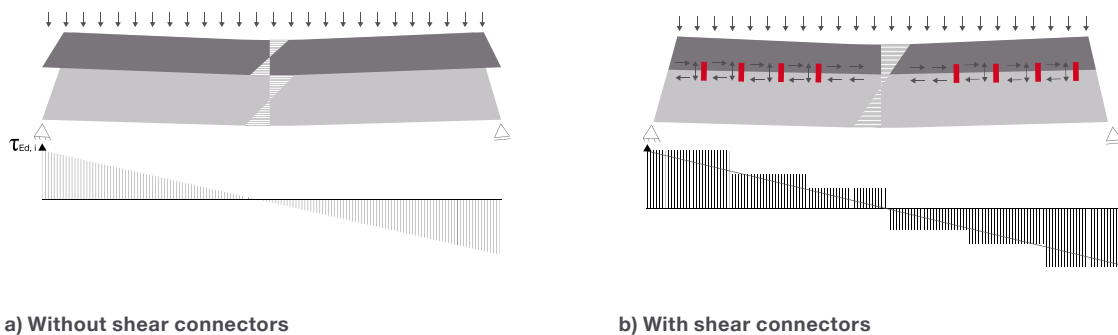

Fig. 2.13: Cross-section stresses associated to shear loading

The **adhesion** component results from chemical adhesive bonds between the particles of the old and new concrete. When the maximum load-bearing capacity of the adhesive bond is reached (which usually happens at the service loads), detachment occurs at the interface between the concrete layers. Then, the shear stresses are transferred by **mechanical interlocking** due to surface roughness.

As the relative displacement between the concrete layer increases, the shear connectors crossing the interface are stressed and the shear connectors may fail by yielding, by pullout failure or by other concrete related failure modes such as concrete breakout or splitting. As a result of the resistance of the shear connectors, the interface is subjected to compression and the shear forces are transmitted by **friction**.

Due to the relative displacement of the concrete layers, the post-installed shear connector is also subjected to shear force, which is usually referred to as **dowel effect**.

Fig. 2.14b shows the individual contribution of the three factors of shear transfer, and it is important to note these three mechanisms do not contribute simultaneously. With increasing surface roughness, the shear resistance and the shear stiffness of the composite joint increases considerably. Also note that the distribution of the total resistance between the three load-bearing components changes. In extreme cases, when the interface is very rough, the connectors at the joint are mainly subjected to tensile stress, whereas with a smooth interface the dowel stress on the connectors in shear is predominant.



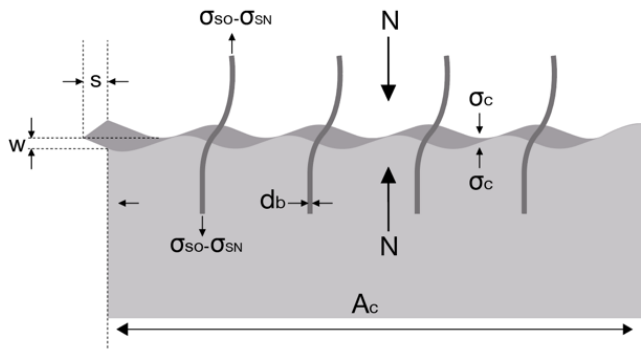

a) Shear transfer across interface

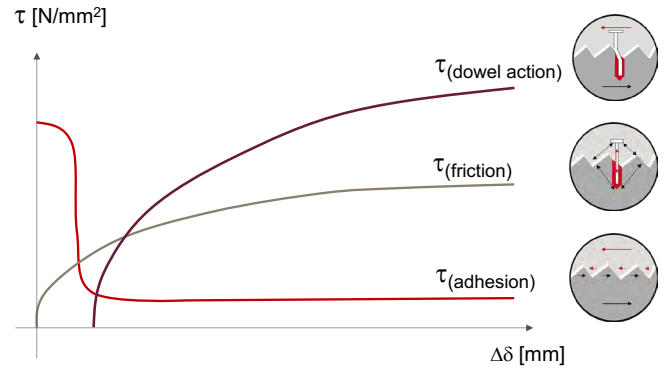

b) Contributing factors

Fig. 2.14: Shear transfer mechanism

## 3. REGULATORY FRAMEWORK FOR QUALIFICATION & DESIGN

### 3.1 Overview of the European regulatory framework

Structural connections using post-installed rebars are allowed in all applications where straight cast-in rebars (CIR) are designed and constructed as per the governing national building codes based on Eurocodes. However, the suitability of the entire system of post-installed rebars including the material (mortar, rebars) and installation method employed must be proven comparable in performance to the cast-in rebar system (in terms of load/displacement behavior under different influencing parameters) by an authorized independent body. Only such proven post-installed rebar systems may be designed according to the established design standards.

The construction products regulation (CPR) lays down harmonized rules for marketing of construction products in Europe. CPR (Regulation (EU) No. 305/2011) provides conditions for placing a construction product on the market and establishes harmonized rules on how to express performance of construction products with the EU through governmental authorities such as European Committee for Standardization (CEN). The **European Committee for Standardization (CEN)** provides the platform for the development of European Codes, Standards and other technical documents in relation to various kinds of products, materials, services, and processes. **Eurocodes (EC)** and standards published by CEN serve as reference documents to design and build, prove compliance, specify contracts of building and civil engineering works, as well as providing a regulatory framework for drawing up harmonized technical specifications for construction products, construction works and related engineering services.

**Note:** the Eurocodes are enforced in the CEN member states jointly with applicable national regulations (e.g., National annexes to single Eurocodes).

The performance assessment of post-installed rebar systems is ruled by **European Assessment Documents (EADs)** developed by the **European Organisation for Technical Assessment (EOTA)** which comprises of all **Technical Assessment Bodies (TABs)** designated by Member States of the European Union and the European Economic Area (e.g., DIBt in Germany, CSTB in France, ITC-CNR in Italy, etc.). EADs deal with preconditions, assumptions, required tests, assessments of essential performance characteristics and their qualification criteria. The construction systems according to a particular EAD are assessed with **European Technical Assessments (ETAs)**, issued by TABs. ETAs showcase the qualified performance characteristics of the products and their evaluated installation methods.

EOTA also coordinates the application of the procedures set out for a request for an ETA and for the procedure adopting an EAD. Also, in addition and supplementary to the European codes and standards, **EOTA Technical reports (TR)** are developed as supporting documents to EADs which contain detailed aspects relevant to construction products such as design, execution and evaluation of tests. The overall high-level function of the European Regulatory Framework is depicted in Fig. 3.1.

**Note:** EOTA is in charge of assessment of construction products (in case there is no harmonized EN). Design is addressed by CEN. However, if no design exists for a construction product and its intended use, EOTA provides also design documents (typically issued as TRs). These design documents shall not be in contradiction or conflict with CEN design documents.

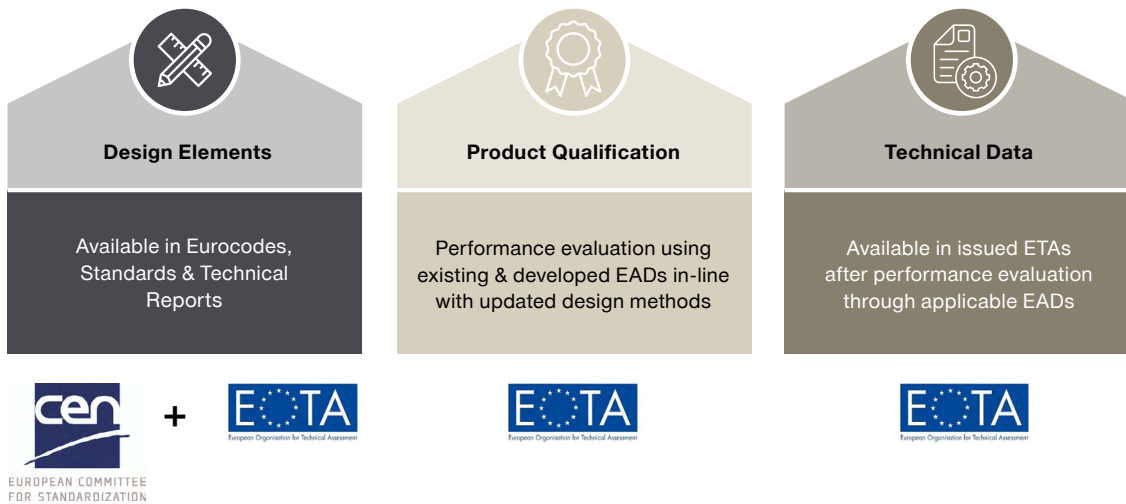

Fig. 3.1: European framework for design and assessment of post-installed rebar solutions

## 3.2 Design of post-installed rebar applications

### 3.2.1 Eurocode design provisions

Extensive research programs (conducted by individuals and in technical academic institutions across the world, e.g., [5], [6]) have contributed to the development of the complete assessment according to EAD 330087 [7]. This specific assessment revolves around the concept of equivalency in performance (i.e., bond strength and load-displacement behavior) between a post-installed rebar system and cast-in rebar system. Key issues include the robustness of the post-installed rebar system to adverse environmental and loading conditions as well as its installation.

**Note:** Eurocodes shall be referred as follows throughout this handbook, e.g., EN 1992-1-1 as EC2-1-1.

Therefore, the design method and provisions for cast-in rebars in EC2-1-1 [1] can be utilized for post-installed rebar systems assessed according to the EAD 330087 [7]. The basic anchorage length, design anchorage length and design lap splice length for concrete-to-concrete member connections are calculated using provisions in section 8 of EC2-1-1 [1]. Fig. 3.2 schematically shows the design bond strength of CIR according to EC2-1-1 [1]. The only limitation is that only applications that are allowed with straight anchorages and laps can be realized with post-installed rebars. In a similar manner the provisions of EC2-1-2 [8] and EC8-1 [9] may be applied when fire exposure and seismic actions are respectively considered.

**Note:** EC2-1-1 [1] does not include specific provisions for the design of connections with post-installed reinforcement. However, the EAD 330087 [7] refers to EC2-1-1 [1] as applicable design standard documents for post-installed rebar systems accordingly assessed and proven.

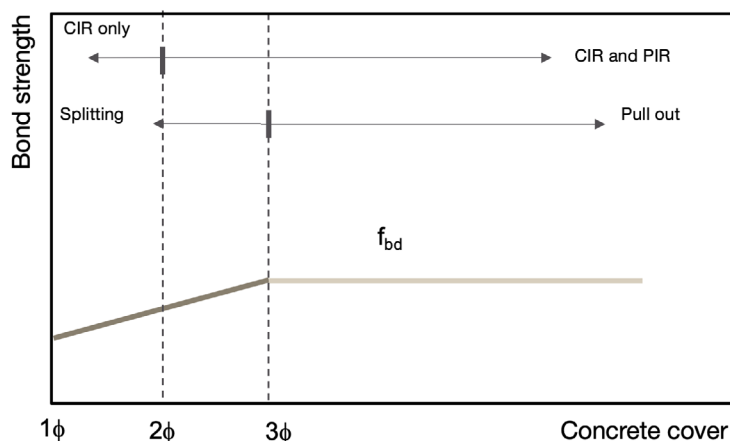

Fig. 3.2: Bond strength capacity according to EC2-1-1 [1]



### 3.2.2 Applications covered by EC2-1-1 design provisions

The provisions of EC2-1-1 [1] can be used to design the following applications (refer Fig. 3.3) in which no concrete cone failure takes place as discussed in [chapter 2](#):

- **End anchorage applications** which are simply supported such as beam/slab connected to column/wall.
- **End anchorage applications** with only compression load connections such as column/wall connected to slab/foundation/girders.
- **End anchorage applications with bending moments** assuming that the tension forces are balanced by local and global struts based on a suitable strut-and-tie model such as column/wall connected to slab/foundation/girders and beam/slab connected to column/wall.
- **Lap splice applications** such as slab/beam/column/wall extensions.
- **Shear friction applications** such as overlays when the design embedment depth of the shear connectors (i.e., rebars used as dowels) does not exceed the maximum possible installation depth in the base material and overlay concrete (basically, only thick overlay applications).

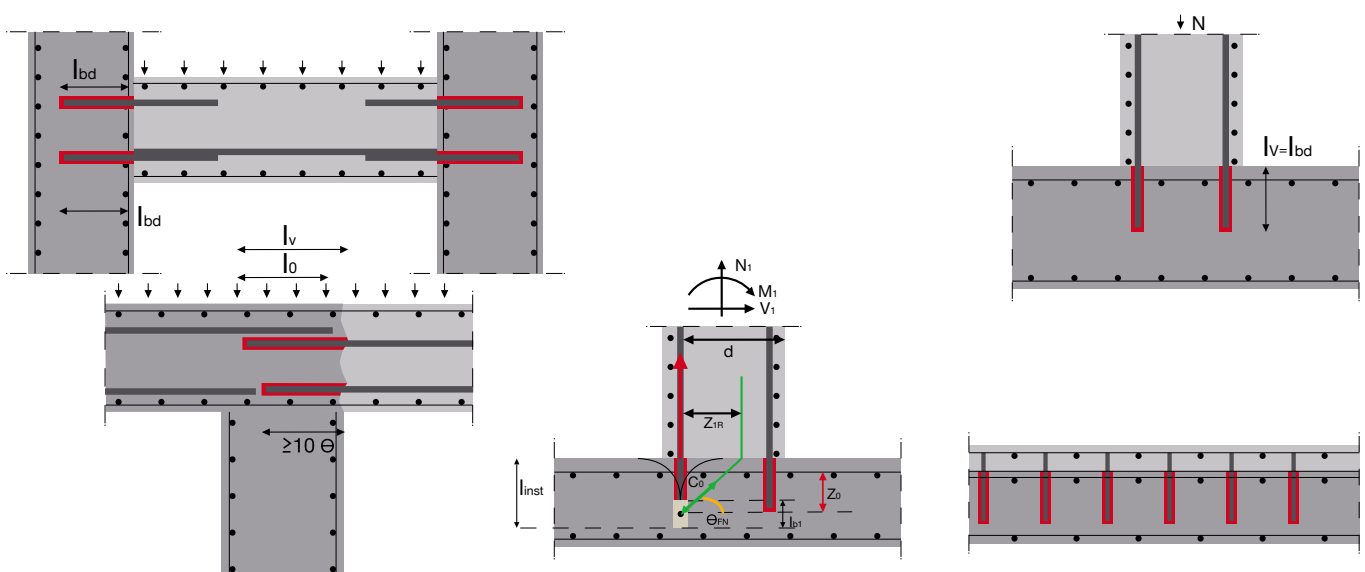
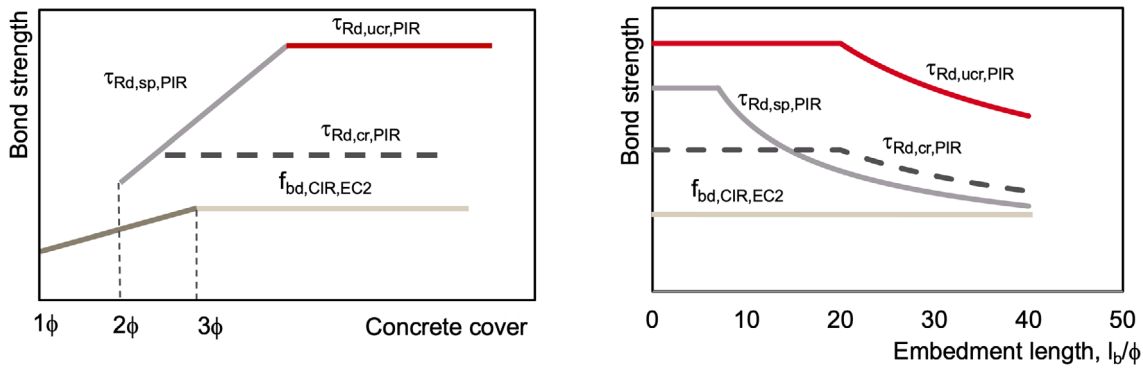

Fig. 3.3: Post-installed rebar applications covered by EC2-1-1 [1] design provisions

Refer to [chapter 5](#), [chapter 6](#) and [chapter 7](#) for more details on the design provisions of EC2-1-1 [1] for lap splices, end anchorages and shear-friction (overlay) applications respectively. Specific requirements applicable to post-installed rebars are included.

### 3.2.3 EOTA TR 069 provisions and covered applications

EOTA TR 069 [2] provides a design method for post-installed rebar connection systems where structural elements are experiencing moment actions based on **improved bond-splitting behavior**. This includes possible different modes of failure such as steel yielding, concrete cone failure, resistance to pull-out and splitting failure. Furthermore, the product-dependent bond strength of the specific post-installed rebar system is considered via assessment according to the EAD 332402 [10] and its variants [11] and [12]. Refer Fig. 3.4 which schematically shows the bond strength performance as a function of concrete cover and as a function of embedment length. For most cases, the actual bond strength values of post-installed rebar systems are higher than the limiting bond strength values of CIR as per the EC2-1-1 [1] design provisions (as seen in Fig. 3.4).



a) Influence of concrete cover/rebar spacing

b) Influence of anchorage length

Fig. 3.4: Bond strength performance

Overcoming the limited application range discussed in section 3.2.1 with the new design standard EOTA TR 069 [2] and qualified products assessed through relevant EADs, the following additional applications of post-installed rebar connection systems can be designed (refer Fig. 3.5):

- Column-to-slab moment connection
- Wall-to-slab/foundation moment connection
- Slab-to-wall moment connection
- Beam-to-wall/column moment connection

Refer to [chapter 6](#) for design details of anchorage of post-installed reinforcing bars following the provisions of EOTA TR 069 [2].

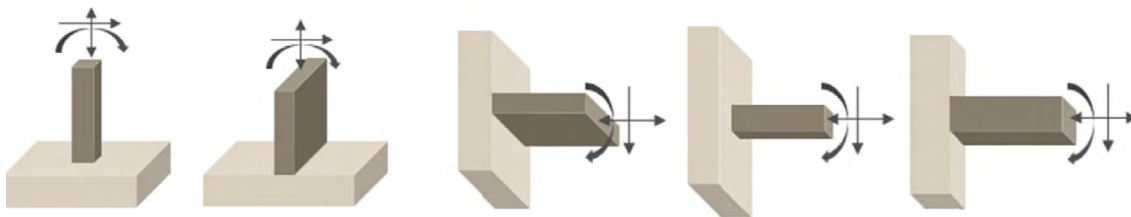

Fig. 3.5: Typical design applications covered by EOTA TR 069 [2]

### 3.3 Assessment of post-installed rebar systems

#### 3.3.1 EAD 330087 (Assessment of post-installed rebar suiting EC2-1-1 design provisions)

EAD 330087 [7] covers the assessment of post-installed rebar connection systems of embedded straight rebars in adhesive mortar surrounded by concrete, to be designed in accordance with provisions given in EC2-1 [1], to prove the compatibility performance of post-installed rebar to cast-in place rebar connections. This EAD covers application of post-installed rebar connections in structures subject to static or quasi-static (EC2-1-1 [1]), seismic loading (EC8-1 [9]) as well as fire action (EC2-1-2 [8]). It is pertinent to note that EAD 330087 [7] has superseded earlier assessment criteria document EOTA TR 023 [13] for post-installed rebar connection performance evaluation. The scientific background for this assessment method can be found in the work of several researchers, e.g., [5], [6], [14], [15] and [16].

Tests for assessing performance and determining the essential characteristics are conducted in configurations like cast-in-place reinforcement in which pull-out controls the behavior. Basic reference tension tests in crack/uncracked in different concrete grades, under various conditions like robustness to adverse environmental and loading are prescribed. The post-installed rebar system can be assessed for a design working life of 50 or 100 years. Determined values of the performance characteristics are published in an ETA. The key requirements verified from the EAD prequalification testing are shown in Fig. 3.6.

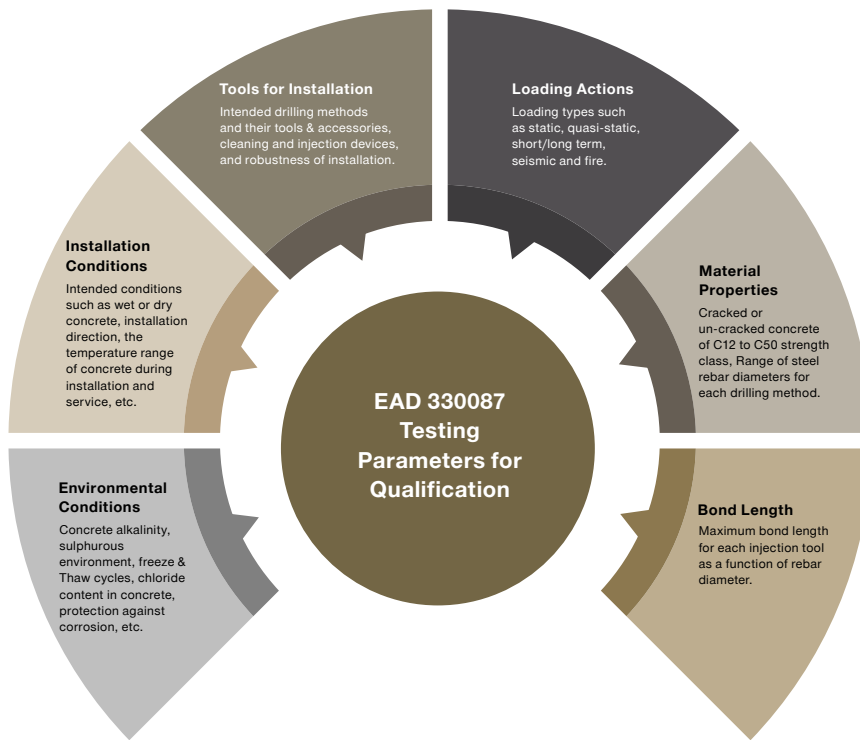

Fig. 3.6: Scope of assessment of post-installed rebar systems according to EAD 330087 [7]

An alternative assessment method for a post-installed rebar system to EAD 330087 [7] is provided by the EN 1504-6 [17]. Both assessments enable a CE-Marking of a product. However, the differences in terms of assessed parameters are significant, as shown in Table 3.1.

**Note:** Post-installed rebar systems with a CE-Marking according to EN 1504-6 should not be used for structural applications.

Table 3.1: Comparison of assessment of post-installed rebar systems according to EAD 330087 [7] and EN 1504-6 [17]

Parameter	EAD 330087	EN 1504-6
Concrete strength	C20/25 – C50/60	C(0,40) as per EN 1766 [18] (C50/60)
Uncracked concrete	✓	✓
Cracked concrete	✓	-
Sensitivity to installation conditions	✓	-
Installation at low and high temperatures	✓	-
Drilling method	✓	⚠ (not spec. in CE-Mark)
Borehole direction	✓	
Sustained load at 21°C	✓ (50/100 years)	⚠ (3 months)
Sustained load at elevated temperatures	✓ (50/100 years)	-
Freeze-thaw cycles	✓	-
Resistance to alkalinity	✓	-
Corrosion protection	✓	-



### 3.3.2 EAD 332402 (Assessment of post-installed rebar suiting EOTA TR 069 design provisions)

In addition to assessment according to EAD 330087 [7], including its limitations of the application range of post-installed rebar connections, the post-installed rebar connection systems are more comprehensively evaluated in terms of product-dependent performance characteristics using assessment from EAD 332402 [10] (see Fig. 3.7). The qualified products as per EAD 332402 [10] and their performance characteristics can be used in the design method according to EOTA TR 069 [2] for efficient designs. Additionally, EAD 332402 [10] (and its variants) has overcome EAD 330087's [7] limitations in the performance assessment of post-installed rebar for cracked as well as uncracked concrete, in terms of improved bond splitting behavior used in EOTA TR 069 [2]. The scientific background for the EAD 332402 [10] and the EOTA TR 069 [2] has been provided by [19], [20], [21] and [22].

**Note:** The performance assessment as per EAD 332402 [10] is only applicable for post-installed rebar connection systems that are pre-qualified according to EAD 330087 [7] and EAD 330499 [25]. Fig. 3.7 briefly shows the combination of these assessments.

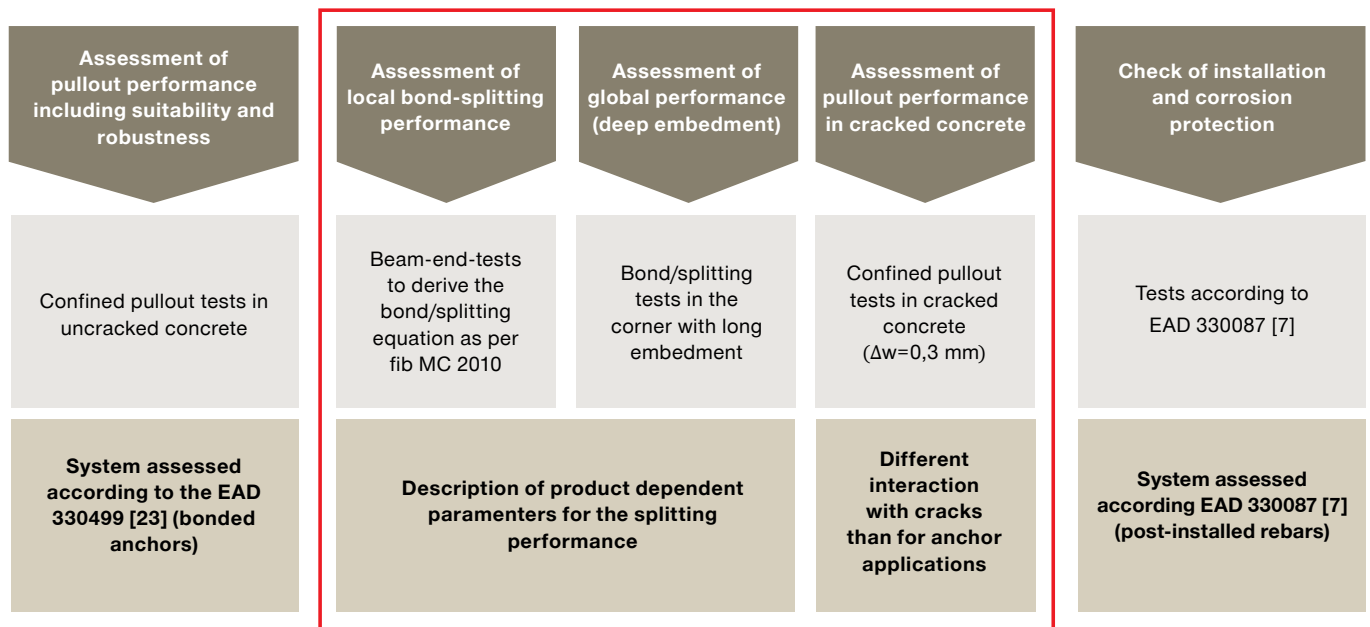

Fig. 3.7: Assessment of post-installed rebars according to EAD 332402 [10]

The evolution of post-installed rebar assessment and design methods over the last two decades is depicted in Fig. 3.8.

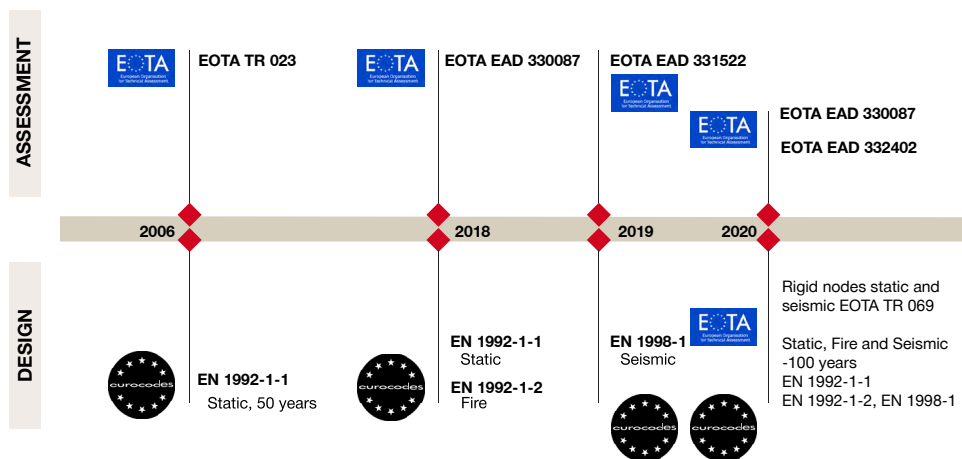

Fig. 3.8: Evolution of post-installed rebar assessment and design methods

**Note:**

(i) Post-installed rebars are generally designed to resist only axial forces and not the shear transfer at the interface. Hence, necessary shear capacity checks at the interface need to be verified as per applicable codes and standards (e.g., EC2-1-1 [1]).

(ii) Additional verifications considering all failure modes of existing and new concrete such as shear resistance of nodal panels and local transfer of forces in the existing member must be done as per applicable codes and standards.

### 3.4 Design of post-installed shear-friction (overlays) applications

#### 3.4.1 EC2-1-1 design provisions

The design for shear friction connections between two concrete layers cast at different times is ruled by the provisions of EC2-1-1, section 6.2.5 [1]. However, the design provisions in EC2-1-1 [1] cover only applications with a full anchorage of rebars (steel yielding) used as dowels on both sides of the interface. This condition cannot be fulfilled in many interventions, where reinforced concrete members are strengthened by adding a thin layer of concrete overlay and/or there is an existing thin layer of base concrete. For this reason, EOTA has developed a specific design guideline to address such applications, i.e., EOTA TR 066 “Connector for strengthening of existing concrete structures by concrete overlay” [4].

#### 3.4.2 EOTA TR 066 design provisions

This design method targets strengthening the existing concrete structure by adding a new concrete layer to existing members. The anchors used as shear connectors (or dowels) across the interface may be anchored as a bonded fastener or concrete screw in the existing concrete and should exhibit a radial symmetric head in the new concrete.

EOTA TR 066 [4] allows the design and dimensioning of these connections and the interface considering all load bearing components (**adhesion/interlocking, friction, and dowel action**) and other product-specific factors from relevant ETA.

#### Typical applications covered by EOTA TR 066 Provisions

Overcoming the limited application range discussed (thick shear overlays) in the EC2-1-1 [1] provisions for post-installed shear connector systems, with the new design method EOTA TR 066 [4] and qualified products assessed through the EAD 332347 [23], the following typical shear friction applications (refer Fig. 3.9) can be designed:

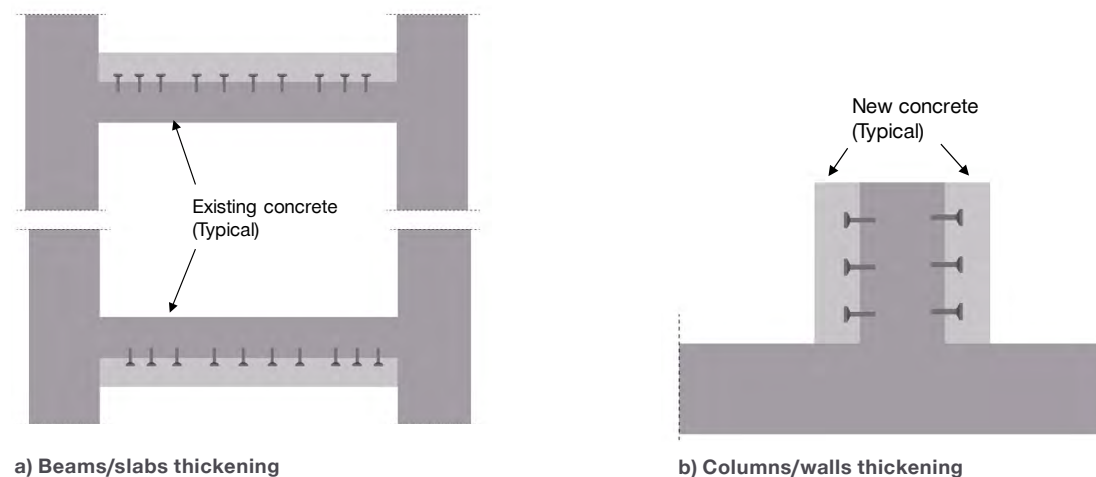

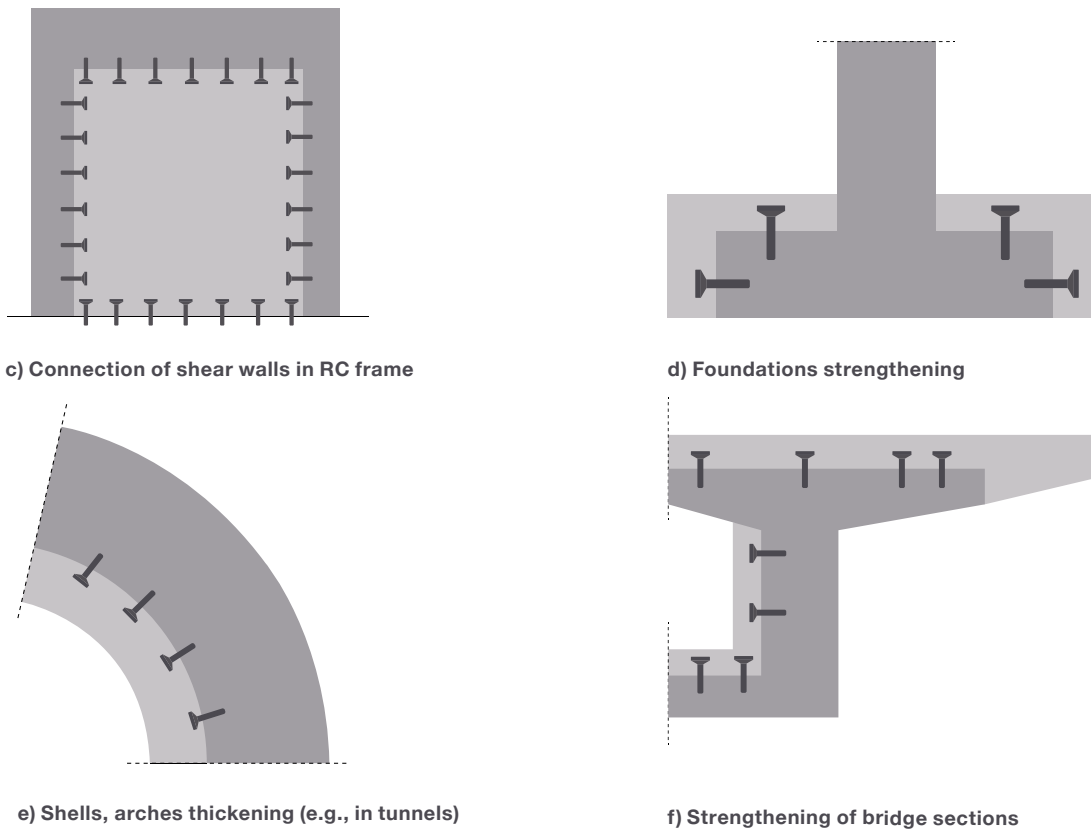

Fig. 3.9: Typical overlay applications covered by EOTA TR 066 [4]

## 3.5 Assessment of post-installed shear connector systems

### 3.5.1 EAD 332347 Assessment

The purpose of EAD 332347 [23] (and its variant to cover seismic actions [24]) is to provide assessment methods for essential characteristics of shear connectors which are used for design of the shear-friction connections (overlays) under static, quasi-static and fatigue cyclic loading according to EOTA TR 066 [4]. The post-installed shear connectors are of the following types based on their shape and working principles:

The part of the connector, which is anchored in the existing concrete, can be of bonded fasteners complying according to EAD 330499 [25] or concrete screws complying according to EAD 330232 [26] (see Fig. 3.10). Refer to the steel-to-concrete handbook for further details on their assessment criteria. The part of the connector in the concrete overlay is anchored by mechanical interlock with an anchor head or a shaped head (refer EAD 332347 [23]).

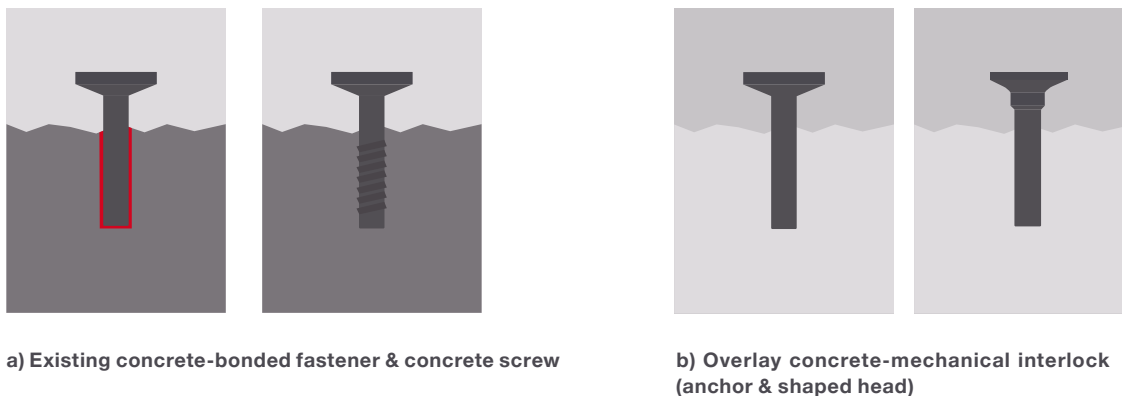

Fig. 3.10: Types of shear connectors in existing concrete and overlay concrete covered by EAD 332347 [23]

The assessment for shear connectors under static and quasi static loading is based on the material properties (steel ductility) and geometry of the cross-section (bending stiffness) of the connectors. To assess the suitability to resist fatigue and seismic action, appropriate system tests have been designed. Additionally, the performance of the connectors is assessed following the principles of Anchor Theory (refer Table 2.1) to allow for the check of their pullout resistance, which is relevant for the calculation of the interface shear resistance according to provisions of EOTA TR 066 [4].

Characteristic performance tests for tension loading in seismic categories C1 and C2 as per EC2-4 [3] and shear interface parameters assessment tests for fatigue loading, seismic loading are also conducted for the shear connectors as per EAD 332347 [23]. The evaluated parameters and their values are published in ETAs for the products. The evolution of shear connectors assessment and design methods are depicted in Fig. 3.11.

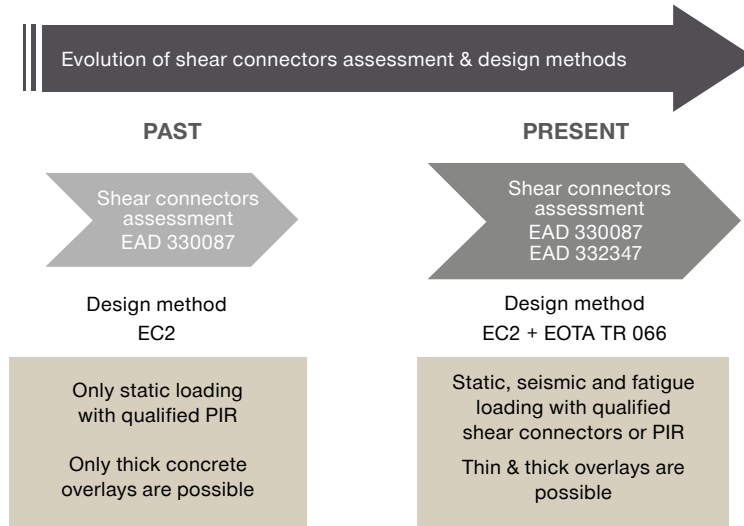

Fig. 3.11: Evolution of post-installed shear connectors assessment and design methods

### 3.6 Summary

The essential parameters for the design of post-installed rebar and shear connector systems according to different assessments (EADs) are summarized in Table 3.2.









Table 3.2: Design & assessment summary of post-installed rebar connection systems

Assessment/design parameter	EAD 330087	EAD 332402	EAD 332347
Load actions	Static, fire, seismic	Static, fire, seismic	Static, seismic & fatigue
Design method	EC2-1-1, EC2-1-2, EC8-1	EOTA TR 069	EOTA TR 066
Application range	According to EC2-1-1 (e.g., lap splices, anchorages, shear-friction applications)	Anchorage in moment resisting connections	Shear-friction overlays
Failure modes considered	Steel yielding, pullout & splitting of concrete	Steel yielding, concrete breakout & improved bond-splitting of concrete	According to Anchor Theory (EC2-4)
Minimum concrete cover	2 $\phi$	2 $\phi$	5 $\phi$
Sufficient confinement	Assumed (local or global strut)	Not assumed	Not assumed
Minimum bond Length	$l_{b,min}$ or $l_{o,min}$ according to EC2-1-1 (typ. $l_{b,min} = 10\phi$ and $l_{o,min} = 15\phi$ )		40 mm
Maximum bond Length	60 $\phi$ (Typ.)	60 $\phi$ (Typ.)	20 $\phi$
Working life	50 / 100 Years	50 / 100 Years	50 Years

A summary of design methods for post-installed rebars and post-installed shear connectors, their product assessment (EAD), technical data (ETA), and their application ranges are presented in Table 3.3



Table 3.3: Summary of assessments &amp; design methods for post-installed concrete-to-concrete connections

	Lap splices / Anchorages			Anchorages in rigid Connections			Shear-friction applications / Overlays			
										
Load	Static	Seismic	Fire	Static	Seismic	Fire	Static	Seismic	Fire	
Working life	50 / 100 years			50 / 100 years			N / A	50/100 years	50 years	N / A
Product assessment	EAD 330087			EADs 330087/ 332402	EAD 332042	EADs 330087/ 332347		EAD 332347		
Technical data	ETA I			ETA I / ETA II	ETA II	ETA I / ETA III		ETA III		
Design Method	EC2-1-1	EC8-1	EC2-1-2	EC2-1-1 / EOTA TR 069	EOTA TR 069	EC2-1-1 / EOTA TR 066		EOTA TR 066		

\* Note: Eurocodes are referenced by EAD 330087 and ETA I, but currently, they do not consider PIR

## 3.7 Reinforced concrete material

To use the European framework for qualification of post-installed systems, design methods and installation techniques, the following properties of reinforced concrete materials are to be satisfied:

### 3.7.1 Concrete and its required properties:

The concrete referred to in this handbook for post-installed connection systems (post-installed rebars or shear connectors) shall be designed and detailed, planned and produced, transported, placed, compacted, cured and tested according to the requirements of applicable Eurocodes and standards. The concrete material shall also satisfy the following requirements:

1. Normal weight concrete (without fibers) conforming to EN 206 [27] of strength classes C12/15 to C50/60 (for post-installed rebar ETAs) and C20/25 to C50/60 (for shear friction overlays ETAs).
2. Unreinforced normal weight concrete shall have minimum detailing requirements as per EC2-1-1 [1] when used for structural purposes.
3. The concrete shall be non-carbonated.
4. The maximum allowed chloride content in the concrete for intended use according to EN 206 Table 15 [27] are Cl 0.20 % or 0.40 (related to cement content) depending on the product ETA.

### 3.7.2 Rebar and its required properties:

The reinforcing bars (rebars) referred to in this handbook are hot-rolled deformed steel and de-coiled rods whose properties are conforming to EN 10080 [28] & EC2-1-1, Annex C (class B or C) [1] as well as applicable national regulations (e.g., national annexes to Eurocodes). Summarizing, rebars in post-installed systems shall satisfy the following requirements:

1. The minimum and maximum diameter of rebars applicable shall be according to ETA
2. The minimum and maximum embedment length of rebars shall be according to EC2-1-1 [1] & ETA
3. The minimum and maximum grade of rebars shall be 400 MPa - 600 MPa conforming to EC2-1-1 [1]
4. The rib height of the rebar shall be in the range of  $0.05 \cdot \varnothing \leq h_{rib} \leq 0.07 \cdot \varnothing$
5. The minimum value of related rib area  $f_R$  of rebars shall be according to EC2-1-1 [1]
6. The maximum outer diameter of rebars over the rib shall be  $1.14 \cdot \varnothing$

**Note:** Contact Hilti engineering support for design of applications using materials and material properties other than those mentioned in this section.





Note: Contact Hilti for applications in different concrete types (e.g., C90/105 or light weight concrete).

## 4. HILTI SOLUTIONS

### 4.1 Solutions for post-installed rebar applications

For the entire application range of post-installed rebar systems (refer to [chapter 2](#) and [chapter 3](#)), the main Hilti solutions are assessed according to the applicable EADs with published ETAs are presented in Table 4.1.

Table 4.1: EOTA-qualified products for post-installed rebar applications

PRODUCTS	HIT-RE 500 V4	HIT-HY 200-R V3	CT-1	FP700-R
				
Rebar diameters	8 to 40 mm	8 to 40 mm	8 to 25 mm	8 to 40 mm
Design	Eurocode & EOTA TR 069	Eurocode & EOTA TR 069	Eurocode	Eurocode
Approval	ETAs 20/0539, 20/0540	ETAs 19/0600, 19/0665	ETA 11/0390	ETA 21/0624
Performance attributes	Static, seismic & fire	Static, seismic & fire	Static & fire	Static, seismic & fire
Max. service life	100 years *	100 years	50 years	100 years
Min. / Max inst. temperature	-5°C / +40°C	-10°C / +40°C	-5°C / +40°C	+5°C / +40°C
Work. time @ 20°C	30 min.	9 min.	4 min.	20 min.
Curing time @ 20°C	7 hours	60 min.	75 min.	10 days
Drilling method**	HD, HDB, HD+RT, HD, CA	HD, HDB, HD+RT, CA	HD, HDB, CA	HD, HDB, HD+RT, CA
Max. embedment	3200 mm	1000 mm	700 mm	2500 mm

\* 120 years with Hilti technical data beyond the scope of the ETA



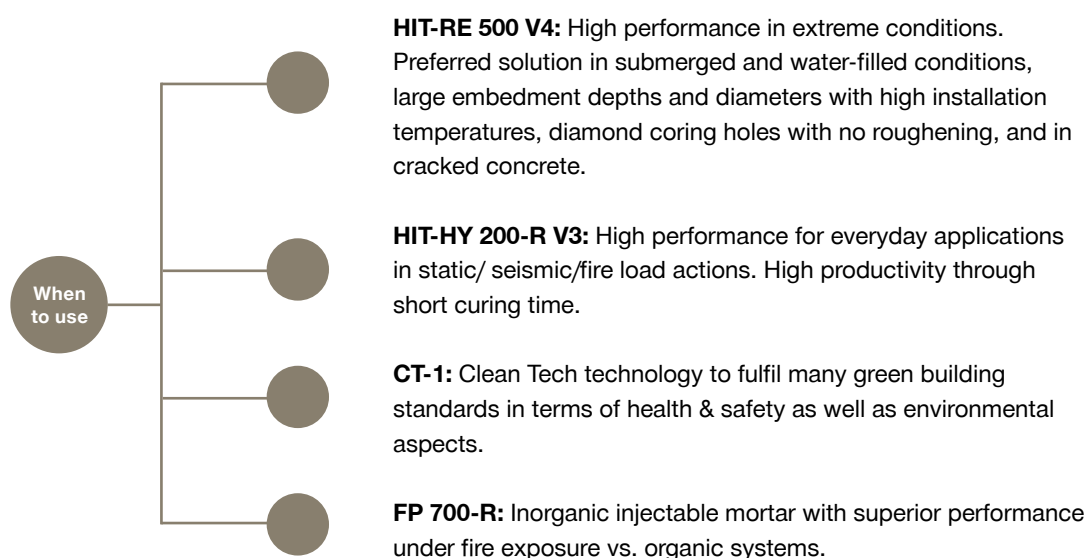

\*\* Refer to Chapter 9 for proper installation with a more efficient & safer tool 'Hilti SafeSet™ system'



## 4.2 Solutions for post-installed shear friction (overlay) applications

For the entire application range involving the use of shear connectors (refer [chapter 2](#) and [chapter 3](#)), Hilti product solutions are qualified according to the EAD 332347 [23] with published ETAs that are presented in Table 4.2. Generally, shear connectors are employed in the form of stud anchors, however, shear connection systems can be established using post-installed rebars with straight end embedded in existing concrete layer and hooked end placed in the fresh layer of concrete.

Table 4.2: EOTA-qualified products for post-installed shear connectors for concrete overlays

PRODUCTS	HUS4-H	HAS-U (HCC-U)	HCC-K	HCC-B	Hooked Rebar *
					
Portfolio size (Diameter in mm)	8,10,12,14,16	M8 to M30	10,12,14,16	14	8 to 25
Head shape	Hex head with optional rebar connector	Nut or plate	Bolt head	Optimized head bolt and rebar connector	Bent
Approval	ETA 21/0969	ETA 20/0697	ETA 20/0475	ETA 18/1022	ETAs for HIT-RE 500 (20/0539) and HIT-HY 200-R (19/0600)
Performance attributes	Static & seismic	Static	Static	Static & fatigue	Static & seismic
Immediate loading	Yes	No	No	Yes (1 kN)	No
Adjustability	During setting	Cutting before setting	Cutting before setting	During setting	Cutting before setting

\* Hilti technical data since anchor element outside of the scope of the EAD 332347 [23].

## 4.3 Design and execution process steps

For any project involving design of post-installed rebar or post-installed shear connector applications, for both planned and unplanned applications (refer Fig. 4.1), the structural and material properties need to be identified, and design requirements and target parameters need to be set. The following process outlines the general approach that can be used in the design and construction of concrete-to-concrete connections using post-installed systems for **planned applications**.

1. **Conceptual design phase:**
  - a) Determine the architectural and structural criteria like shape, size, span, thickness, exposure, durability requirements and sustainability requirements for the project
  - b) Determine existing structure type, structural elements and their details
  - c) Select general design criteria and objectives, governing codes/standards, ETAs, solution selection criteria and preliminary design values to start with
2. **Structural analysis:**
  - a) Determine design loading requirements (static, seismic, fire)
  - b) Determine installation conditions relevant to design
  - c) Calculate cross-section and material properties
  - d) Choose appropriate design method
  - e) Set target capacity (utilization ratio) and/or allowable stress limits
  - f) Determine load combinations

Note: Refer to the Hilti Fastening Technology Manual (FTM) for product performance to be used for conceptual design.



**3. Detailed design / specification:**

- a) Calculate and check basic anchorage length
- b) Calculate design anchorage length/lap splice length
- c) Check with available installation length in base member
- d) Calculate and check service and ultimate stress limits
- e) Check utilization ration for different failure modes and their combinations

**Note:** Use Hilti PROFIS Engineering for detailed design (refer [Ch. 8](#)).



**4. Construction documents:**

- a) Prepare construction drawing showing position, spacing and embedment of post-installed rebars or shear connections
- b) Call out specifications on the adhesive mortar, their installation and injection methods
- c) Provide inspection/quality control requirements for the jobsite

**5. Execution:**

- a) Procure product solutions and installation equipment
- b) Locate and fix the positions of rebars after scanning the base material for any intrusions (metals or other foreign objects)
- c) Surface preparation (required roughening using the right tools and techniques as per the Instructions For Use (IFU) ) for shear friction applications
- d) Drill and clean using the right tools and techniques mentioned in ETA(s) as per IFU
- e) Onsite inspection & testing as part of quality control at the job site
- f) Request information/change/review based on feedback during execution and quality control
- g) Change control and implementation (if any) following the above relevant design and execution steps

**Note:** Use Hilti's SafeSet for a safe & reliable installation (refer [Ch. 9](#)).



**Unplanned applications** include the necessity of installation of post-installed systems in a job site which could rise from missed-out reinforcing bars (intentional/non-intentional) in structural elements for establishing monolithic connections. For such unplanned applications, a design engineer can follow the above laid-out process steps starting from Step 2.

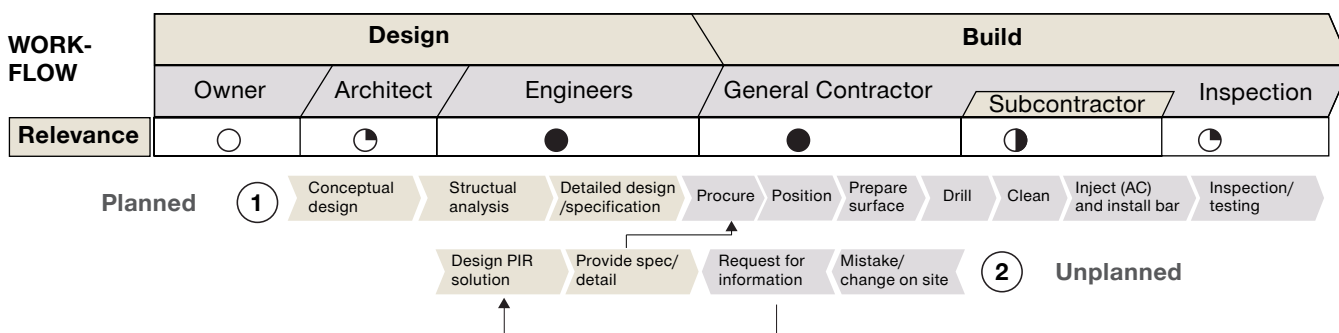

Fig. 4.1: General workflow of post-installed rebar design & installation

**4.4 Hilti as total system solution provider**

The **designer's** biggest challenges are creating optimized and approved design solutions, with easy documentation in the shortest span of time and with enhanced productivity using available man-hours. For **contractors**, typical challenges are in productivity, health and safety, environmental, quality, and skilled labor. All these challenges related to post-installed reinforcement can lead to time pressure, poor installation quality, health and safety issues for laborers and compromises with the ultimate resistance of improperly installed rebars.

Hilti partners with various stakeholders to mitigate these challenges by supporting the processes to make design and installation faster, safer, and more productive as total system solution provider (see Fig. 4.2) enabling collaboration between designers, contractors, and inspectors.



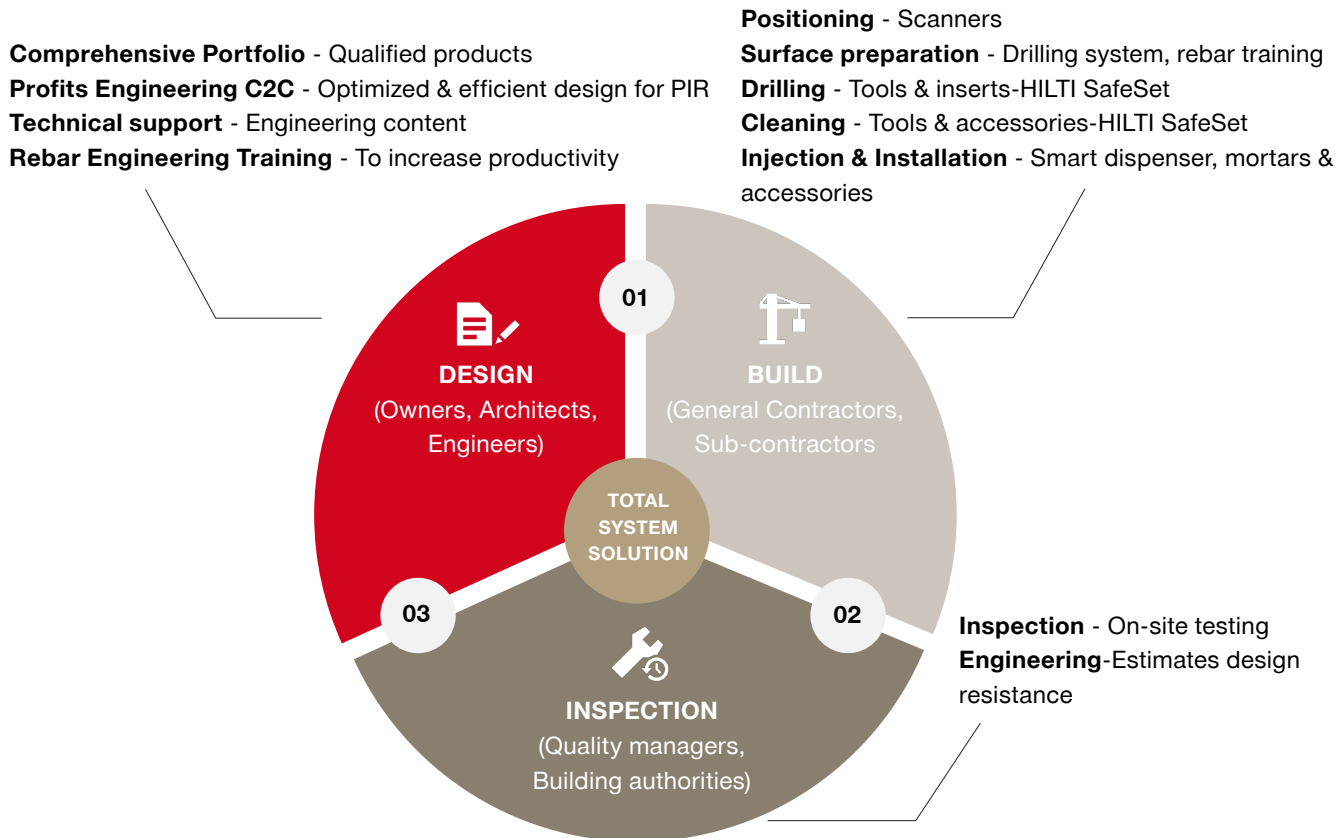

Fig.4.2: Hilti as a total system solution partner



**Qualified Products**

Tested & EOTA approved products & tools (Hardware) to provide required performance & safety



**Optimized Design Solutions**

Design software to enhance optimization, efficiency & overall productivity



**Safe & Fast Installation**

Services & products to partners in every challenge for safer & faster construction activities

## 5. DESIGN OF LAP SPLICES

### 5.1 General

In the previous chapters, we have discussed various applications and their load transfer mechanisms, which can be designed using qualified post-installed solutions within the applicable EU regulatory framework. Lap splices are the preferred way to ensure a monolithic connection between existing and new concrete members. This chapter focuses on the design steps to calculate the required splice length for post-installed rebars. Load actions such as static, seismic and fire are considered as per the design provisions of EN 1992-1-1 (EC2-1-1 [1], for static), EN 1992-1-2 (EC2-1-2, for fire) [8], and EN 1998-1 (EC8-1, for seismic) [9]. Lap splice connections can be of two types (refer Fig. 5.1):

**Cast-in rebar to cast-in rebar splice:** this splice connection is generally seen in structural elements established during construction before concrete is poured where the cast-in rebars are laid out as per the design detailing. This type of splice is usually built as a contact splice since the cast-in rebars are in contact with each other along the splice length. The load is transferred primarily through the contact between rebar ribs.

**Cast-in rebar to post-installed rebar splice:** this splice connection is established when post-installed rebar is parallel to cast-in rebars of existing concrete elements. This type of splice is a non-contact splice since post-installed rebar installation involves drilling inside existing concrete without damaging the cast-in rebar. The primary load transfer is via local compression struts formed between the two rebars.

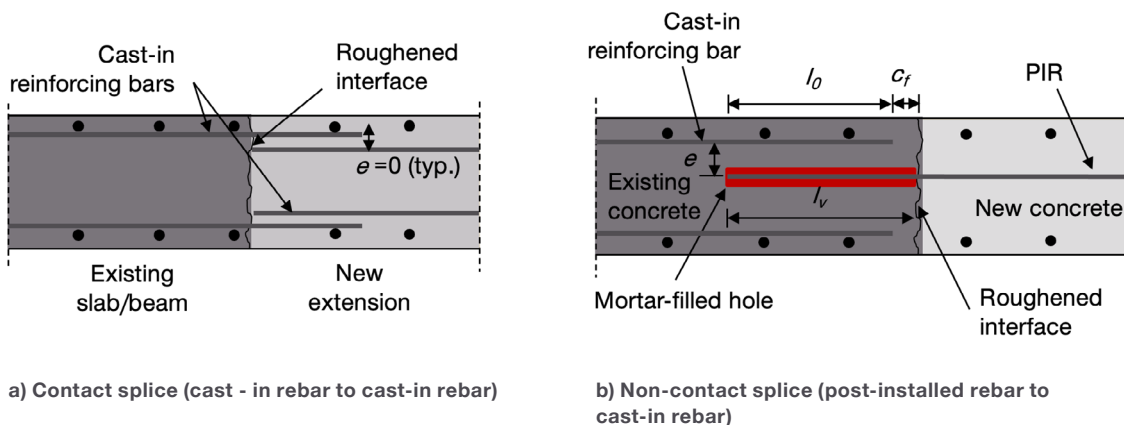

Fig. 5.1: Lap splice connection types

### 5.2 Design for Static Actions

The design of lap splices with qualified post-installed rebars for static and quasi-static load actions follows the provisions of EC2-1-1 section 8.7 [1], which are very similar as for cast-in rebars. Additional applicable provisions are given in the EAD 330087 [7]. Design steps of lap splice connections using post-installed rebars are as follows:

For cast-in rebars the basic required anchorage length  $l_{b,rqd}$  based on a constant bond stress  $f_{bd}$  is given by the equation:

$$l_{b,rqd} = (\phi/4) \cdot (\sigma_{sd}/f_{bd}) \quad \text{EC2-1-1 eq. (8.3)}$$

Where,

$\sigma_{sd}$  is the design stress of the rebar

$\phi$  is the diameter of the rebar

For cast-in rebar the design bond strength  $f_{bd}$  is given by the equation,

$$f_{bd} = 2.25 \cdot \eta_1 \cdot \eta_2 \cdot f_{ctd} \quad \text{EC2-1-1 eq. (8.2)}$$

where,

$\eta_1$  is 1.0 or 0.7 (coefficient based on bond conditions and rebar position as per EC2-1-1, sect. 8.4.2 [1])

$\eta_2$  is 1.0 for  $\phi \leq 32$  mm or  $(132 - \phi)/100$  for other  $\phi$

$f_{ctd}$  is the design tensile strength of concrete class used.

For post-installed rebars, the corresponding design bond strength  $f_{bd,PIR}$  is utilized from the relevant product ETA instead of  $f_{bd}$  according to EC2-1-1 eq. (8.2) of the cast-in rebar system, hence for post-installed rebars equation 8.3 becomes:

$$l_{b,rqd,PIR} = (\phi/4) \cdot (\sigma_{sd}/f_{bd,PIR}) \quad \text{EC2-1-1 eq. (8.3) + EAD 330087}$$

**Note:**  $f_{bd,PIR}$  for some products can be lower than  $f_{bd}$  for a cast-in rebar.

**Note:** Bond conditions are influenced by the position of a rebar in concrete (top-cast condition leading to possible air voids along bond length and lower tensile strength of concrete). Air-voids are not of concern in post-installed rebar since they are installed in hardened concrete. However, the factor  $\eta_1$  still applies for post-installed rebar because of possible lower tensile strength of concrete.

The final design lap length  $l_0$  required is given by the equation:

$$l_0 = \alpha_1 \cdot \alpha_2 \cdot \alpha_3 \cdot \alpha_5 \cdot \alpha_6 \cdot l_{b,rqd} \geq l_{0,min,PIR} \quad \text{EC2-1-1, eq. (8.10)}$$

For post-installed rebar, the minimum lap length  $l_{0,min,PIR}$  in the above equation shall be multiplied with coefficient  $\alpha_{lb}$ , taken from the relevant ETA:

$$l_{0,PIR} = \alpha_1 \cdot \alpha_2 \cdot \alpha_3 \cdot \alpha_5 \cdot \alpha_6 \cdot l_{b,rqd,PIR} \geq \alpha_{lb} \cdot l_{0,min} \quad \text{EC2-1-1, eq. (8.10) + EAD 330087}$$

1)  **$\alpha_1$  is dependent on the shape of rebars.**

For post-installed rebars which are straight in shape, the value of  $\alpha_1$  fixed as 1.0

2)  **$\alpha_2$  is dependent on the concrete cover to the rebars** which is part of passive confinement

$\alpha_2$  value ranges from 0.7 to 1.0 dependent on the formula  $\alpha_2 = 1 - 0.15 \cdot (c_d - \phi)/\phi \geq 0.7$  where  $c_d$  is dependent on the position of rebar as shown in Fig. 5.2

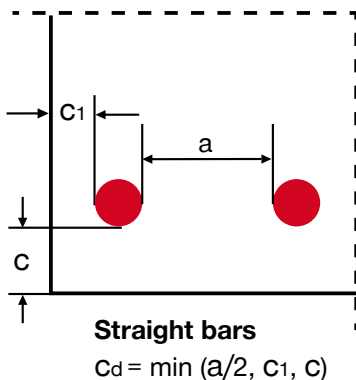

Fig. 5.2: Coefficient based on concrete cover and rebar spacing

- 3)  $\alpha_3$  is dependent on the transverse reinforcement which is also part of passive confinement  
 $\alpha_3$  value ranges from 0.7 to 1.0 dependent on the formula  $\alpha_3 = 1 - K\lambda \geq 0.7$   
 where:

$$\lambda = \Sigma A_{st} / A_s$$

$\Sigma A_{st}$  is cross-sectional area of the minimum transverse reinforcement anchorage length

$A_s$  is the cross-sectional area of a one lapped rebar

$$\Sigma A_{st, min} = 1.0 A_s (\sigma_{sd} / f_{yd})$$

$K$  is the coefficient ranging from 0, 0.05 or 0.1 related to the position of the post-installed rebar as shown in Fig. 5.3

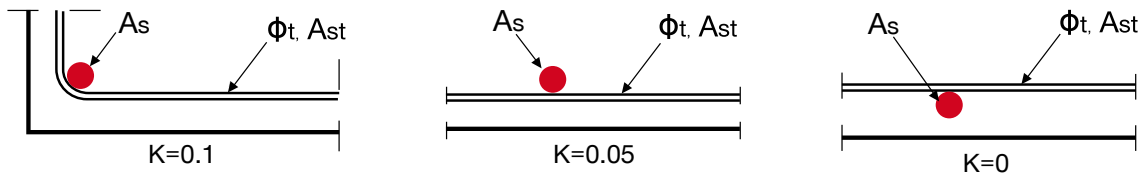

Fig. 5.3: Values of K for beams and slabs

- 4)  $\alpha_4$  is dependent on confinement by welded transverse reinforcement to the rebar where value is 0.7 for cast-in rebars, hence for post-installed rebars  $\alpha_4$  is fixed as 1.0
- 5)  $\alpha_5$  is dependent on the effect of active confinement from pressure transverse ' $p$ ' ( $N/mm^2$ ) perpendicular to the plane of splitting along the design anchorage length where  
 $\alpha_5 = 1 - 0.04p \geq 0.7$  and  $\leq 1.0$
- 6)  $\alpha_6$  is dependent on the percentage of lapped rebars ( $p_1$ ) within 0.65 times lap length ( $l_0$ ) from the center of the lap location considered relative to the total cross-section area of rebars, where  $\alpha_6$  value ranges from 1.0 to 1.5 based on the formula  $\alpha_6 = (p_1/25)^{0.5}$ . In connections with post-installed rebars the percentage of lapped bar at the interface between existing and new concrete is usually 100%. (Refer also to national regulations amending the provisions of EC2-1-1 [1])
- 7)  $\alpha_b$  is dependent on the product performance (ETA) which amplifies the minimum anchorage length  $l_{0, min}$ . The value of  $\alpha_b$  ranges from 1.0 to 1.5

The summary of coefficients and their values for post-installed rebars is presented in Table 5.1.

Table 5.1. Summary of " $\alpha$ " coefficients for post-installed rebars

Coefficients according to EC2-1-1	Rebar in tension	Rebar in compression
$\alpha_1$ - Rebar shape	$\alpha_1 = 1.0$	$\alpha_1 = 1.0$
$\alpha_2$ - Concrete cover	$\alpha_2 = 0.7$ to $1.0$ $\alpha_2 = 1 - 0.15 \cdot ((c_d - \phi)) / \phi \geq 0.7$	$\alpha_2 = 1.0$
$\alpha_3$ - Transverse reinforcement not welded (passive confinement)	$\alpha_3 = 0.7$ to $1.0$ $\alpha_3 = 1 - K\lambda$	$\alpha_3 = 1.0$
$\alpha_4$ - Transverse reinforcement welded to post-installed rebars - non-existent	$\alpha_4 = 1.0$	$\alpha_4 = 1.0$
$\alpha_5$ - Transverse pressure (active confinement)	$\alpha_5 = 0.7$ to $1.0$ $\alpha_5 = 1 - 0.04p$	$\alpha_5 = 1.0$
$\alpha_6$ - Lapped rebars %	$\alpha_6 = 1.0$ to $1.5$ (or according to national regulation)	$\alpha_6 = 1.0$ (or according to national regulation)
$\alpha_b$ - Increasing factor of minimum lap length	Taken from the ETA	Taken from the ETA

\* Note: According to EC2-1-1, eq. (8.5) the product  $\alpha_2 \cdot \alpha_3 \cdot \alpha_5$  shall not be smaller than 0.7



The final design lap length,  $l_0$ , obtained using the above-mentioned equations and coefficients shall be checked against the minimum lap splice length shown below such that  $l_{0,PIR} \geq l_{0,min,PIR}$

$$l_{0,min,PIR} = \alpha_{lb} \cdot \max\{0.3 \cdot \alpha_6 \cdot l_{b,rqd}; 15 \cdot \phi; 200 \text{ mm}\} \quad \text{EC2-1-1, eq. (8.11) + EAD 330087}$$

Note: The maximum lap length calculated for the lapping cast-in and post-installed reinforcement is decisive.

### 5.2.1 Detailing rules

The designer must pay special attention to detailing the reinforcement as per the code and product ETA requirements (concrete cover, spacing, substrate thickness, surface roughness, etc.) so that the spalling or large cracks do not occur while necessary load transmissions are assured. In addition to meeting the durability requirements and detailing requirements for reinforcing bars, whichever are applicable as per section 4, section 8, section 9 of EC2-1-1 [1], the following pertinent detailing rules needs to be satisfied for installation of post-installed rebars (Fig. 5.4):

- If the clear distance between lapped bars 'e' exceeds  $4\phi$  or 50 mm, then the overlap length  $l_0$  shall be increased by a length equal to  $(e-4\phi)$  or  $(e-50 \text{ mm})$  as per section 8.7.2 of EC2-1-1 [1].
- The minimum clear spacing between two post-installed bars shall be greater than 40 mm or  $4\phi$ . In case of drilling aid is used, then  $4\phi$  can be replaced by  $2\phi$ .

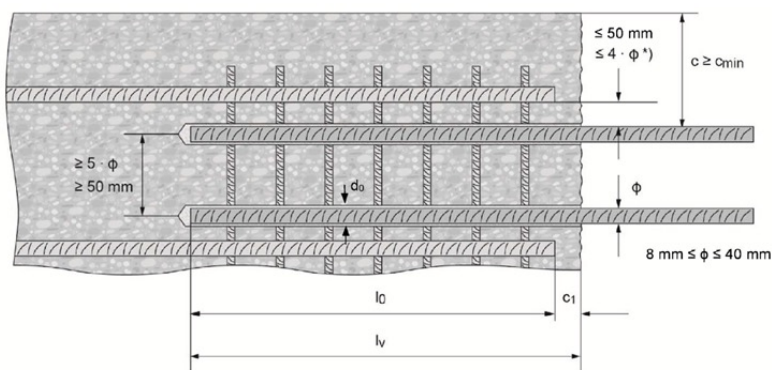

\*) If the clear distance between lapped bars exceeds  $4 \cdot \phi$  or 50mm, then the lap length shall be increased by the difference between the clear bar distance and the smaller of  $4 \cdot \phi$  or 50mm

Where,  $l_v$  is the installation depth.

Fig. 5.4: Rebar detailing rules for post-installed rebar system from ETA

- To prevent damage to the concrete during drilling, the following minimum concrete cover  $c_{min}$  requirements, according to the EAD 330087 [7] need to be met, depending upon the drilling methods (see Fig. 5.5):

Drilling method	Bar diameter [mm]	Minimum concrete cover $c_{min}$ [mm]	
		Without drilling aid	With drilling aid
Hammer drilling (HD) and (HDB) <sup>1)</sup>	$\phi < 25$	$30 + 0,06 \cdot l_v \geq 2 \cdot \phi$	$30 + 0,02 \cdot l_v \geq 2 \cdot \phi$
	$\phi \geq 25$	$40 + 0,06 \cdot l_v \geq 2 \cdot \phi$	$40 + 0,02 \cdot l_v \geq 2 \cdot \phi$
Diamond coring with roughening with Hilti roughening tool TE-YRT (RT)	$\phi < 25$	$30 + 0,06 \cdot l_v \geq 2 \cdot \phi$	$30 + 0,02 \cdot l_v \geq 2 \cdot \phi$
	$\phi \geq 25$	$40 + 0,06 \cdot l_v \geq 2 \cdot \phi$	$40 + 0,02 \cdot l_v \geq 2 \cdot \phi$

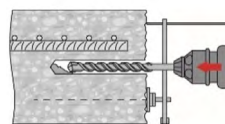

\* Note: 1) HDB = Hollow Drill Bit HILTI TE-CD and TE-YD

Comments: The minimum concrete cover acc. EN 1992-1-1 must be observed.

Fig. 5.5: Minimum concrete cover requirements from EAD 330087 [7] for post-installed rebars

**Note:** The minimum concrete cover  $c_{min}$  according to EAD 330087 [7] is an indication based on investigations by [5]. Keeping these minimum values does not automatically ensure an installation without cracking or spalling of the cover. It is important to use a suitable tool by trained personnel (see [Ch. 9](#) for more detailed information).

### 5.2.2 Durability requirements

The durability of the post-installed rebar application shall not be less than its intended working life. During this period of use, rebars should not be adversely affected by environmental factors such as corrosion of the rebars due to carbonation of the concrete. This is ensured by the following:

- A qualified mortar of the post-installed rebar system ensures a corrosion protection of the rebar not less than in the case of a cast-in rebar.
- Concrete clear cover  $c_{min} = \max(c_{min,dur}; c_{min,ETA})$   
 where  $c_{min,dur}$  is the minimum cover required for different exposure classes according to EC2-1-1 [1]  
 and  $c_{min,ETA}$  is the minimum concrete cover given in the relevant ETA.

## 5.3 Design for seismic actions

For design of lap splice lengths of post-installed rebars under seismic actions, the provisions for static case of cast-in reinforcement remains valid according to EC8-1, Section 5.6.1 [9]. However, for post-installed rebars the suitability of the mortar to resist seismic (cyclic) loading must be checked in seismic assessments under various influencing parameters and values of design bond strength ( $f_{bd,seis}$ ) as provided in the respective ETAs. Hence the following equation in the basic lap length design calculations is modified as:

$$l_{b,rqd,seis} = (\phi/4) \cdot (\sigma_{sd}/f_{bd,seis}) \quad \text{EC2-1-1 eq. (8.3) + EAD 330087}$$

Depending on structural design intent of the application it may be advisable to replace  $\sigma_{sd}$  with yield stress of the rebar  $f_{yd}$  in the calculations.

These requirements are mainly motivated by the need to avoid a possible pullout failure, which is obviously a non-desirable failure mechanism when large deformations are expected (e.g., plastic mechanism).

Hence the design lap splice length equation under seismic actions becomes:

$$l_{0,PIR,seis} = \alpha_1 \cdot \alpha_2 \cdot \alpha_3 \cdot \alpha_5 \cdot \alpha_6 \cdot l_{b,rqd,seis} \geq l_{0,min,PIR} \quad \text{EC2-1-1, eq. (8.10) + EAD 330087}$$

**Note:** The minimum concrete cover shall be  $c_{min,seis}$  instead of  $c_{min}$  taken from the relevant ETA for seismic loads.

All the other coefficient values and design calculations for seismic remain the same as for static loading. Additional detailing rules of lap splices according to EC8-1 [9] and applicable national regulations shall be considered for post-installed rebar connections as well.

**Note:**  $f_{bd,seis}$  is dependent on the seismic product performance according to the relevant ETA.

## 5.4 Design for fire exposure

The chemistry and mechanical properties of organic mortars are significantly affected by high temperatures. For post-installed rebar connections that are a part of fire-rated assemblies (floor, roof, etc.) it is important that the fire resistance of the connections is evaluated considering the fire exposure time (according to EC2-1-2 [8], between 30 and 240 minutes), geometrical boundary conditions and temperature distribution.

For lap splices the temperature distribution along the lap length is, for most common scenarios, a constant and is based on the concrete cover and time exposure (see Fig. 5.6a). In addition, the temperature distribution variation in end anchorages/intersection connections usually varies along the embedment of the rebar (see Fig. 5.6b and section 6.5)

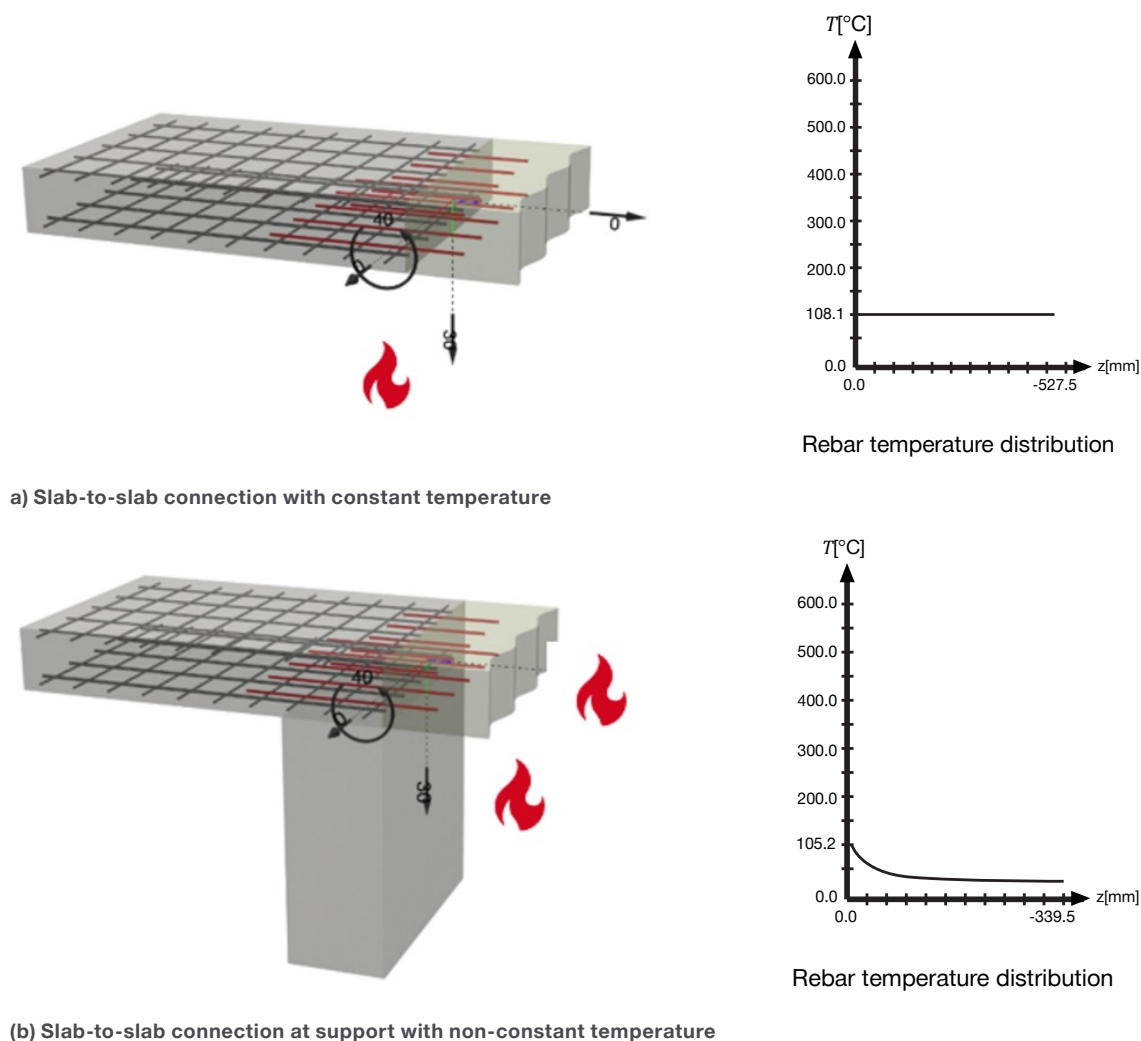

Fig. 5.6: Typical temperature distribution in lap splice connection

Following the performance assessment of chemical mortar products under fire conditions, the temperature-dependent reductions to bond strength values at elevated temperatures are presented in the relevant ETA(s). For cross-section design of structural members under fire exposure, EC2-1-2 [8] provides three methods which are described in Table 5.2.

**Note:** The assessment of the behavior of post-installed rebar systems according to EAD 330087 [7] is based on the ISO standard fire curve according to ISO 834-1 [55] which is valid for design within the framework of EC2-1-2 [8]. Different assessments may be required for special applications (e.g., in tunnels).

Table 5.2. Fire design methods according to EC2-1-2 [8]

Design method	Design loads	Steel strength verification	Design of cast-in rebar lap splice	Design of post-installed rebar lap splice	Remarks
<b>Tabulated data method (Section 5):</b>  Tabulated data of fire exposure classes and required minimum concrete member dimensions and cover	The cross-section design carried out in "cold" conditions is still valid and no additional checks are required for the design fire exposure	Hot design considering steel strength temp. degradation according to Fig. 5.1*	Calculation in "cold" conditions is applicable	Calculation considering the bond strength reduction due to elevated temperature, taken from relevant ETA  (Design provisions for cast-in rebar apply, if the behavior under fire exposure of the post-installed rebar system is equivalent as the one of a cast-in bar)	Reduced bond strength of post-installed rebar system in ETA is available only up to maximum temperature given in the ETA, $\theta_{\max,ETA}$
<b>Simplified Calculation Methods (Section 4.2):</b>  500°C isotherm method/ Zone method	The cross-section analysis follows provisions of Annex B1 for 500°C isotherm method / Annex B2 for Zone method	Hot design considering steel strength temp. degradation (e.g., Fig. 4.2a*)	Reduced cross-section/zones divided need to be considered		
<b>Advanced Calculation Methods (Section 4.3):</b>  advanced material models for numerical modelling of the entire structure under fire conditions	The cross-section analysis follows provisions of section 4.3. Example: finite element analysis	Hot design considering steel strength temp. degradation (e.g., Fig. 4.2a*)	Reduced cross-section / zones divided need to be considered		

Note: \*Figures referred in the table are from EC2-1-2 [8]

Note: For common design cases, the tabulated method of cross-section design is preferable because of its simplicity.

#### 5.4.1 Basic verification

At ultimate limit state during fire exposure of a member, the design load effects,  $E_{d,fi}$ , shall be not larger than the design fire resistance,  $R_{d,fi}$ , of the member, outlined by the equation below:

$$E_{d,fi} \leq R_{d,fi} \quad \text{EC2-1-2, eq. (2.3)}$$

where,

$$E_{d,fi} = \eta_{fi} \cdot E_d \quad \text{EC2-1-2, eq. (2.4)}$$

Here,  $E_d$  accounts for the design load actions (force or moment) under normal ambient ('cold') conditions:

$\eta_{fi}$  is the reduction factor of recommended simplified value 0.7

#### 5.4.2 Design splice length calculation

The design splice length can be calculated using the same design provisions for a static load case. However, the reduced bond strength capacity from the relevant ETA for fire ( $f_{bd,fi}$ ) shall be used instead of  $f_{bd,PIR}$ . The design bond strength under fire ( $f_{bd,fi}$ ) reduces with increasing temperature as shown in Fig. 5.7a. This curve is then translated into the reduction factor  $k_{fi}(\theta)$  by calculating the ratio of the bond strength values to the reference value for cast-in-rebar for the respective concrete class (see Fig. 5.7b).

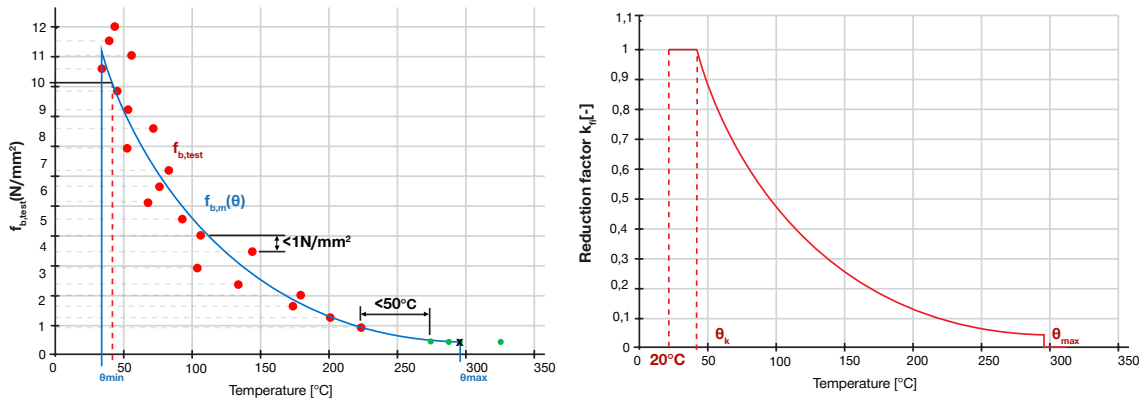

Fig. 5.7: a) Bond-strength as a function of temperature and b) Example of derivation of fire reduction factor  $k_{fi}(\theta)$  (Examples taken from the EAD 330087 [7])

The design bond stress under fire ( $f_{bd,fi}$ ) is calculated using the below equation:

$$f_{bd,fi} = k_{fi}(\theta) f_{bd,PIR} \frac{\gamma_c}{\gamma_{c,fi}} \quad \text{EAD 330087}$$

where,

$k_{fi}(\theta)$  is the reduction factor dependent on exposure temperature taken from ETA

$f_{bd,PIR}$  is the bond strength of post-installed rebar system

$\gamma_c$  is the factor of safety for concrete base material (usually value is 1.5)

$\gamma_{c,fi}$  is the material safety factor for concrete for fire condition is 1.0 (EC2-1-2 [8], Sect. 2.3)

Hence the following equation in the basic lap length design calculations is modified as,

$$l_{b,rqd,fi} = (\phi/4) \cdot (\sigma_{sd}/f_{bd,fi}) \quad \text{EC2-1-2, eq. (8.3) + EAD 330087}$$

Hence the design lap splice length equation for fire load actions becomes,

$$l_{0,fi} = \alpha_2 \cdot \alpha_3 \cdot \alpha_5 \cdot \alpha_6 \cdot l_{b,rqd,fi} \geq l_{0,min,PIR} \quad \text{EC2-1-2, eq. (8.10) + EAD 330087}$$

All the other coefficient values and design calculations for seismic remains the same as for static.

### 5.4.3 Steel Failure verification

The design also considers the residual stress in the steel reinforcement in fire exposure and strength reduction factor  $k_s(\theta)$

$$F_{Ed,fi} \leq F_{yd,fi} = k_s(\theta) \cdot A_s \cdot f_{y,k}/\gamma_{s,fi}$$

where,

$\gamma_{s,fi}$  is the material safety factor for steel for fire condition is 1.0

$A_s$  is the cross-sectional area of rebar(s)

$k_s(\theta)$  is taken from EC2-1-2

### 5.4.4 Simulation approach for reduction factors

The temperature  $\theta$  to calculate the reduction factors for mortar  $k_{fi}(\theta)$  and steel  $k_s(\theta)$  can be taken from EC2-1-2 [8], Annex A for standard structural elements (e.g., beams, columns, slabs, walls) based on design fire temperature. Alternatively, it can be taken from a suitable finite element model simulation (see Fig. 5.8).



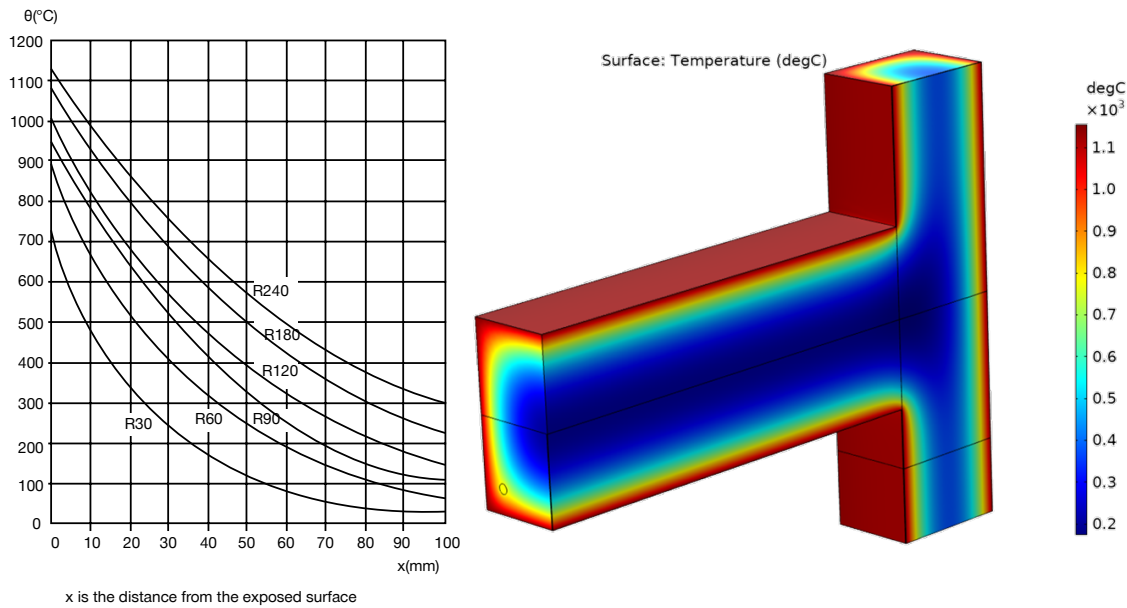

Fig. 5.8: Sample curves to obtain fire reduction factors from a) Annex A of EC2-1-2 [8] for a slab of thickness 200 mm & b) Finite element simulation

### 5.5 Design example of lap splice connection

Project requirement: post-installed rebars are required to extend an existing reinforced concrete slab.

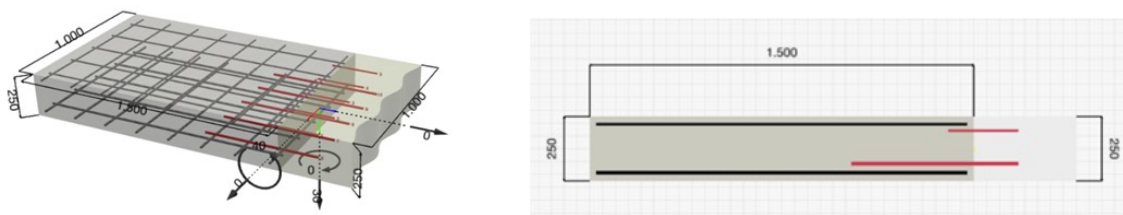

Fig. 5.9: Lap splice connection for slab extension using post-installed rebars

#### General information on existing slab element

- Geometry:
  - Slab thickness,  $h = 250$  mm
  - Slab width,  $w = 1000$  mm
  
- Materials:
  - Normal weight concrete C25/30
  - Reinforcing steel  $f_{yk} = 500$  N/mm<sup>2</sup>
  
- Loading:
  - Bending moment,  $M_{Ed} = 40$  kNm/m
  - Shear,  $V_{Ed} = 30$  kN/m
  - Design working life: 50 years
  
- Cast-in reinforcement:
  - Top layer:  $\phi 10/200$  mm ( $A'_{s,PIR} = 392.6$  mm<sup>2</sup>)
  - Bottom layer:  $\phi 14/200$  mm ( $A_{s,PIR} = 769.5$  mm<sup>2</sup>)
  - Front cover,  $c_f = 25$  mm
  - Top/bottom cover  $c_{d,CIR} = 25$  mm

**Installation condition of post-installed rebars:**

- Drilling method/orientation: Rotary-hammer drilling/horizontal
- Installation/in-service temp.: 10°C/20°C (Long term)/40°C (Short term)
- Post-installed rebar Arrangement: Top and layers same as the cast-in reinforcement  
Top/bottom cover  $c_{d,PIR} = 50/60$  mm
- Design working life: 50 years
- System/Solution choice: Hilti HIT-CT 1 (ETA-11/0390 [29])

**Static design**

Cross-section analysis

To determine the stress in the post-installed rebars a cross-section analysis following the principles of EC2-1-1 [1], is carried out (here using PROFIS Engineering). For this calculation, the contribution of the reinforcement in the compression zone is neglected.

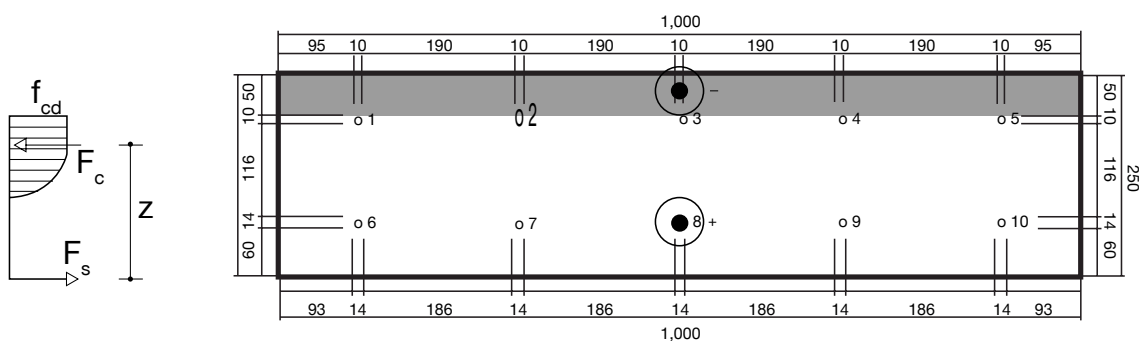

Fig. 5.10: Cross-section analysis

The inner lever arm,  $z = 164$  mm is derived.

Additional tension force on the cross-section due to the shear load according to EC2-1-1 [1], Section 6.2.3 (7):

$$\Delta F_{td} = V_{Ed} \cdot (\cot\theta - \cot\alpha) \quad \text{EC2-1-1, eq. (6.18)}$$

$$\cot\alpha = 0 \quad \alpha = 0^\circ \text{ in the case of vertical stirrups}$$

$$\cot\theta = 1.091 \quad \theta = 42.5^\circ \text{ assumed inclination of the strut}$$

$$\Delta F_{td} = V_{Ed} \cdot (\cot\theta - \cot\alpha) = 30 \cdot 1.091 = 32.7 \text{ KN} \quad \text{distributed between top and bottom layer}$$

The tensile stress in the post-installed bars is calculated as:

$$\sigma_{sd,top} = \Delta F_{td} / A_s = (16.4 \cdot 10^3) / 392.6 = 41.8 \text{ N/mm}^2$$

$$\sigma_{sd,bottom} = (M_{sd} / z + \Delta F_{td}) / A_s = (40 \cdot 10^6 / 164 + 16.4 \cdot 10^3) / 769.5 = 338 \text{ N/mm}^2$$

Design of top layer – post-installed reinforcement

The top bars are unloaded. Therefore, they are simply anchored in the front face of the existing member with minimum length according to EC2-1-1 [1] and the provisions of EAD 330087 [7].

$$l_{b,min,PIR} = \alpha_{lb} \cdot \max\{0.3 \cdot l_{b,rqd}; 10\phi; 100 \text{ mm}\} \quad \text{EC2-1-1, eq. (8.6) + EAD 330087}$$

$$\alpha_{lb} = 1.2 \quad \text{ETA-11/0390}$$

$$l_{b,rqd} = (\phi/4) \cdot (\sigma_{sd}/f_{bd,PIR}) \quad \text{EC2-1-1, eq. (8.3) + ETA-11/0390}$$

$$l_{b,rqd} = (10/4) \cdot (41.8/2.7) = 38.7 \text{ mm}$$

$$l_{b,min,PIR} = 1.2 \cdot \max\{0.3 \cdot 38.7 \text{ mm}; 100 \text{ mm}; 100 \text{ mm}\} = 120 \text{ mm}$$

#### Design of bottom layer – cast-in reinforcement

$$l_{0,CIR} = \alpha_1 \cdot \alpha_2 \cdot \alpha_3 \cdot \alpha_5 \cdot \alpha_6 \cdot l_{b,rqd} \geq l_{0,min} \quad \text{EC2-1-1, eq. (8.10)}$$

Where the  $\alpha$ -factors according to EN 1992-1-1, tab. 8.2, in this case we have:

$$\alpha_1 = 1.0 \quad \text{Straight reinforcement}$$

$$\alpha_2 = 1 - 0.15 \cdot (c_d - \phi)/\phi \geq 0.7 \quad \text{Influence of concrete cover}$$

$$= 1 - 0.15 \cdot (25 - 14)/14 = 0.88$$

$$\alpha_3 = 1 - K\lambda \geq 0.7 \quad \text{Influence of transverse reinforcement}$$

$$\lambda = \Sigma A_{st}/A_s$$

$$A_{st} = 231 \text{ mm}^2; K = 0.05$$

$$\alpha_3 = 1 - 0.05 \cdot 231/154 = 0.93$$

$$\alpha_4 = 1.0 \quad \text{No welded reinforcement}$$

$$\alpha_5 = 1.0 \quad \text{No transverse pressure}$$

$$\alpha_6 = 1.5 \quad \text{EC2-1-1, tab. 8.3}$$

$$l_{b,rqd} = (\phi/4) \cdot (\sigma_{sd}/f_{bd}) \quad \text{EC2-1-1, eq. (8.3)}$$

$$f_{bd} = 2.25 \cdot \eta_1 \cdot \eta_2 \cdot f_{ctd} \quad f_{bd} \text{ acc. to EC2-1-1, eq. (8.2)}$$

$$= 2.25 \cdot 1 \cdot 1 \cdot 1.2 = 2.7 \text{ N/mm}^2$$

$$l_{b,rqd} = (14/4) \cdot (338/2.7) = 438 \text{ mm}$$

$$l_{0,CIR} = 0.88 \cdot 0.93 \cdot 1.5 \cdot 438 = 538 \text{ mm}$$

$$l_{0,min} = \max\{0.3 \cdot \alpha_6 \cdot l_{b,rqd}; 15 \cdot \phi; 200 \text{ mm}\} \quad \text{EC2-1-1, eq. (8.11)}$$

$$l_{0,min} = \max\{141; 210; 200 \text{ mm}\} = 210 \text{ mm}$$

#### Design of bottom layer – post-installed reinforcement

$$l_{0,PIR} = \alpha_2 \cdot \alpha_3 \cdot \alpha_5 \cdot \alpha_6 \cdot l_{b,rqd,PIR} \geq l_{0,min,PIR} \quad \text{EC2-1-1, eq. (8.10) + EAD 330087}$$

Where the  $\alpha$ -factors according to EC2-1-1 [1], Table 8.2 and considering that  $\alpha_1$  and  $\alpha_4$  are not applicable for post-installed reinforcement (refer Table 5.1 of [chapter 5](#)). In this case we have:

$$\alpha_2 = 1 - 0.15 \cdot (c_d - \phi)/\phi \geq 0.7 \quad \text{Influence of concrete cover}$$

$$= 1 - 0.15 \cdot (60 - 14)/14 = 0.51 \rightarrow 0.7$$

$$\alpha_3 = 1 - K\lambda \geq 0.7 \quad \text{Influence of transverse reinforcement}$$

$$\lambda = \Sigma A_{st}/A_s$$

$$A_{st} = 231 \text{ mm}^2; K = 0.05$$

$$\alpha_3 = 1 - 0.05 \cdot 208/154 = 0.92 \rightarrow 1.0$$

$$\text{because } \alpha_2 \cdot \alpha_3 \cdot \alpha_5 \geq 0.7 \quad \text{EC2-1-1, eq. (8.5)}$$

$$\alpha_5 = 1.0 \quad \text{No transverse pressure}$$

$$\alpha_6 = 1.5 \quad \text{EC2-1-1, tab. 8.3}$$

$$l_{b,rqd} = (\phi/4) \cdot (\sigma_{sd}/f_{bd,PIR}) \quad \text{EC2-1-1, eq. (8.3) + ETA-11/0390}$$

$$l_{b,rqd} = (14/4) \cdot (338/2.7) = 438 \text{ mm}$$

$$l_{0,PIR} = 0.7 \cdot 1.5 \cdot 438 = 460 \text{ mm}$$

$$l_{0,min,PIR} = \alpha_{lb} \cdot \max\{0.3 \cdot \alpha_6 \cdot l_{b,rqd,PIR}; 15 \cdot \phi; 200\} \quad \text{EC2-1-1, eq. (8.11) + ETA-11/0390}$$

$$l_{0,min,PIR} = 1.2 \cdot \max\{198; 210; 200\} = 252 \text{ mm}$$

$l_{0,CIR} > l_{0,PIR} \rightarrow$  The lap length of the cast-in rebar is decisive

$$l_{v,PIR} = l_{0,CIR} + c_f = 538 + 25 = 563 \text{ mm} \quad \text{Drilling length}$$

Verification of minimum concrete cover,  $c_{min}$  according to EAD 330087

$$c_{min} = \min\{30 + 0.06l_v; 2\phi\} = 63.8 \text{ mm} < 60 \text{ mm} \quad \text{EAD 330087, tab. 1.2 (without drilling aid)}$$

$$c_{min} = \min\{30 + 0.02l_v; 2\phi\} = 41.3 \text{ mm} < 60 \text{ mm} \quad \text{EAD 330087, tab. 1.2 (with drilling aid)}$$

**Note:** The use of a drilling aid is not mandatory, but recommended since  $63.8 \text{ mm} > 60 \text{ mm}$ .

### Seismic design

Assuming that the same connection has to resist seismic action, the following should be observed:

1. The design of the lap length of the cast-in reinforcement remains valid according to EC8-1 [9], Section 5.6.1.
2. The design of the lap length of the post-installed reinforcement changes, because:
  - a. The system/solution used should be assessed for seismic actions
  - b. The value  $f_{bd,PIR}$  shall be replaced by  $f_{bd,seis}$  in the relevant ETA.
3. Depending on the application it may be advisable to replace  $\sigma_{sd}$  with  $f_{yd}$  in the lap length calculations.

The design action might include reversing of the sign of the bending moment and hence the rebar configuration of the top layer might be different. This situation is not investigated in this example. Repeating the calculation for static and seismic actions using the relevant values included in the ETA-19/0600 [30] following installation lengths,  $l_v$  are obtained:

**Note:** The system Hilti HIT-CT 1 (ETA-11/0390 [29]) is not assessed to resist seismic actions. Therefore, this system/solution has been replaced by the Hilti HIT-HY 200-R V3 (ETA-19/0600 [30]).

Repeating the calculation for static and seismic actions using the relevant values included in the ETA-19/0600 [30] following installation lengths,  $l_v$  are obtained:

System	Rebar	Static loading $l_v$	Seismic loading ( $f_{yd}$ ) $l_v$
HIT-CT 1	Top layer	120 mm	N.A
	Bottom layer	563 mm	N.A
HIT-HY 200-R V3	Top layer	100 mm	<b>100 mm</b>
	Bottom layer	563 mm	<b>697 mm</b>

## Fire design

As it is commonly the case in practice, the new connection shall fulfil fire exposure requirements. In this case a fire exposure class R 60 is required.

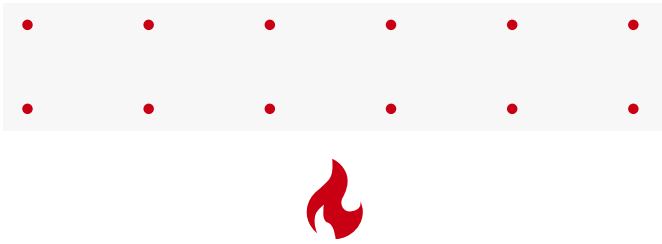

Fig. 5.11: Cross-section of a slab exposed to fire - schematic

**Note:** According to EC1-1 [1] seismic and fire design combination are usually not considered at the same time. Different provisions may be applicable according to national regulations or for applications in special buildings and/or infrastructures.

The loading on the connection may be reduced considering that we are dealing with an accidental loading combination:

$$M_{d,fi} = \eta_{fi} \cdot M_d = 0.7 \cdot 40 = 28 \text{ kNm}$$

$$V_{d,fi} = \eta_{fi} \cdot V_d = 0.7 \cdot 30 = 21 \text{ kNm}$$

The material partial factors also change, being:

$$\gamma_{s,fi} = \gamma_{c,fi} = 1.0$$

The cross-section analysis depends on the adopted design approach. In this case we choose the Tabulated Data approach (EC2-1-2 [8], Section 5). This is possible, because the slab fulfils the requirements of EC2-1-2 [8], Table 5.9 (i.e., for R 60, minimum slab thickness of 180 mm and axial cover of 15 mm). On this basis, the cross-section analysis carried out in “cold” conditions is still valid and the cast-in bars do not need to be checked for the design fire exposure time of 60 minutes. However, the lap length of the bottom layer of the post-installed reinforcement needs to be re-calculated considering the bond strength reduction due to elevated temperature.

The temperature in the post-installed reinforcement is constant over its entire length and it is related to the concrete cover ( $c_{PIR} = 60 \text{ mm}$ ). It can be calculated following the principles of EC2-1-2 [8] or by means of finite elements method, e.g., using PROFIS Engineering. In this case a temperature in the post-installed reinforcement of 181.1°C is calculated.

### Steel Verification

The steel verification under fire exposure is not decisive, because the tabulated data approach is used.

### Design of bottom layer – post-installed reinforcement

For the system HY 200-R V3 (ETA-19/0600 [30]), we obtain the following design bond strength (refer Fig. 5.12):

$$f_{bd,fi} = k_{fi}(\theta) \cdot f_{bd,PIR} \cdot \gamma_c / \gamma_{c,fi} = 0.20 \cdot 2.7 \cdot 1.5 / 1.0 = 0.81 \text{ N/mm}^2 \quad \text{ETA-19/0600}$$

After repeating the calculations valid for the static load combination replacing  $f_{bd,PIR}$  with  $f_{bd,fi}$  a drilling length of 1089 mm is obtained.

$$l_v = 1089 \text{ mm} > l_{v,max} = 1000 \text{ mm}$$

ETA-19/0600, verification not fulfilled 



**Note:**  $l_v > l_{v,max}$  (acc. to the ETA-19/0600). This means that a correct injection of the mortar and installation of the reinforcing bar cannot be ensured, since its feasibility has not been checked in the assessment procedure according to EAD 330087 [7].

For comparison, the Hilti fire resistance systems HIT-HY 200-R V3 (ETA-19/0600 [30]), HIT-RE 500 V4 (ETA-20/0540 [31]) and HIT-FP 700-R (ETA-21/0264 [32]) are used in the calculation of post-installed rebar installation lengths (Refer Fig. 5.12).

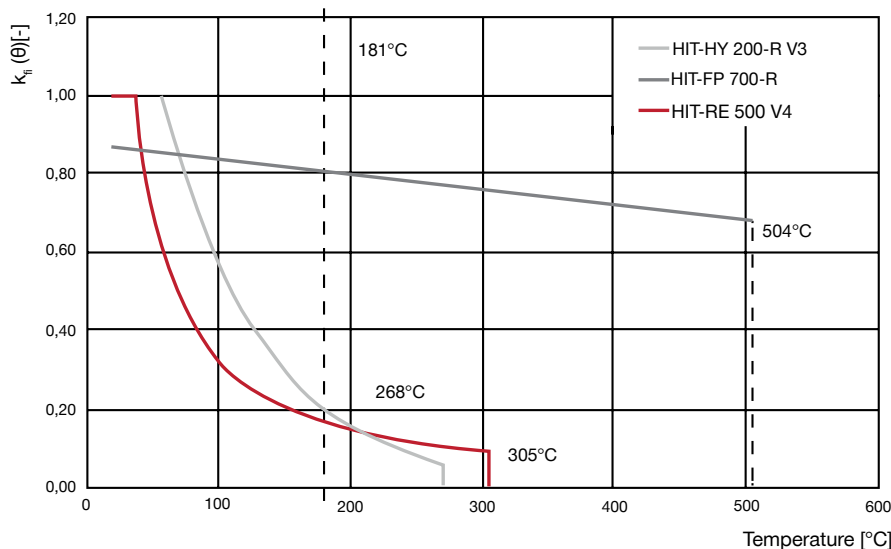

Fig. 5.12: Comparison of performance under fire exposure of the Hilti systems HIT-HY 200-R, HIT-RE 500 and Hilti HIT-FP 700-R in concrete C25/30

The overall results and recommendations of choice of appropriate system/solution are shown below:

System	Rebar	Static, $l_v$	Seismic ( $f_{yd}$ ), $l_v$	Fire, $l_v$
HIT-HY 200-R V3	Top layer	100 mm	100 mm	100 mm
	Bottom layer	563 mm	697 mm	<b>N.A. (1089 mm)</b>
HIT-RE 500 V4	Top layer	100 mm	100 mm	100 mm
	Bottom layer	563 mm	697 mm	<b>1284 mm</b>
HIT-FP 700-R	Top layer	150 mm	150 mm	150 mm
	Bottom layer	569 mm	<b>723 mm</b>	340 mm

**Note:** Considering static, seismic and fire combinations the system HIT-FP 700-R is the preferred choice in terms of embedment lengths among the three alternatives.

#### Additional notes:

- Hilti recommends the total installation length  $l_v$  to be summation of design lap splice length  $l_o$  and the eccentricity ( $e$ ) between the cast-in rebar and post-installed rebar satisfying the detailing requirements (see Fig. 5.1b), up to a maximum  $e = 10 \cdot \varnothing$  (beyond which the local strut action of load transfer might not be valid).
- To complete the design of the connection at ultimate limit state, a check of the interface shear transfer is also required. See [chapter 7](#) of this handbook for more details.

## 6. DESIGN OF END ANCHORAGES

### 6.1 General

End anchorage connections are a category of post-installed rebar applications that usually enable the connection of members perpendicular to existing ones. This application is required when a lap splice with cast-in bars present in the existing member is not possible. This chapter focuses on design steps to calculate the required end anchorage length for post-installed rebar applications in a structural connection using different design methods, for various load actions such as static, seismic and fire as per the design provisions of EN 1992-1-1 (EC2-1-1 [1], for static), EN 1992-1-2 (EC2-1-2, for fire) [8], and EN 1998-1 (EC8-1, for seismic) [9]. Table 6.1 displays the current available design methods for end anchorages for different loading directions (i.e., stress state in the interface), loading types and associated ETA.

Table 6.1. Design methods for end anchorage connections

Design method	Loading direction / stress state in the interface	Loading type	Bond strength (ETA)
Eurocode anchorage	Shear with or without compression	Static / Seismic / Fire	EAD 330087
Eurocode S&T	Bending (uniaxial) and shear with or without compression	Static	EAD 330087
EOTA TR 069	Bending (uni- or bi-axial) and shear with compression or tension	Static / Seismic	EAD 332402

### 6.2 Basic anchorage length according to EC2-1-1

The design of end-anchorages with qualified post-installed rebars for static and quasi-static load actions follows the provisions of EC2-1-1 [1] section 8.4 which are the same as for cast-in rebars. Additional provisions applicable are given in the EAD 330087 [7]. The design steps of anchorage connection using post-installed rebars are as follows:

As already discussed in [chapter 5](#), the basic required anchorage length  $l_{b,rqd,PIR}$  based on a product-specific specific bond strength  $f_{bd,PIR}$  from relevant ETA is given by the equation,

$$l_{b,rqd,PIR} = (\phi/4) \cdot (\sigma_{sd}/f_{bd,PIR}) \quad \text{EC2-1-1 eq. (8.3) + EAD 330087}$$

where:

$\sigma_{sd}$  is the design stress of the rebar

$\phi$  is the diameter of the rebar

The final design anchorage length  $l_{bd}$  required is given by the equation:

$$l_{bd} = \alpha_1 \cdot \alpha_2 \cdot \alpha_3 \cdot \alpha_4 \cdot \alpha_5 \cdot l_{b,rqd,PIR} \geq l_{b,min,PIR} \quad \text{EC2-1-1, eq. (8.4) + EAD 330087}$$

Where:

$l_{b,min,PIR}$  is the minimum anchorage length given by the equations,

$$l_{b,min,PIR} > \alpha_{lb} \cdot \max\{0.3 \cdot l_{b,rqd,PIR}; 10 \cdot \phi; 100 \text{ mm}\} \quad \text{(tension)} \quad \text{EC2-1-1, eq. (8.6)}$$

$$l_{b,min,PIR} > \alpha_{lb} \cdot \max\{0.6 \cdot l_{b,rqd,PIR}; 10 \cdot \phi; 100 \text{ mm}\} \quad \text{(compression)} \quad \text{EC2-1-1, eq. (8.7)}$$

$$l_{bd,PIR} = \alpha_1 \cdot \alpha_2 \cdot \alpha_3 \cdot \alpha_4 \cdot \alpha_5 \cdot l_{b,rqd,PIR} \geq l_{b,min,PIR} \quad \text{EC2-1-1, eq. (8.4) + EAD 330087}$$

Where the influencing 'α' coefficients are the same as already explained in [chapter 5](#).

According to the design philosophy of EC2-1-1 [1], these provisions apply straightforwardly when the anchorage is in a portion of the existing element where the concrete is in compression, e.g., anchorage of longitudinal bars of a column or wall loaded predominantly in compression. Other situations are described in the following sections (see Fig. 6.1).

In the case of slab/beam connecting to a wall/column, the connection is often modeled and designed as simply supported. This assumption is linked to pre-conditions and precautions explained in section 6.2.1. Here, there is primarily transfer of a shear force and no design bending moment is considered (Fig. 6.1a). Alternatively, a connection can be considered rigid/moment-resistant when it needs to be designed for bending moment along with the design shear force (Fig. 6.1b).

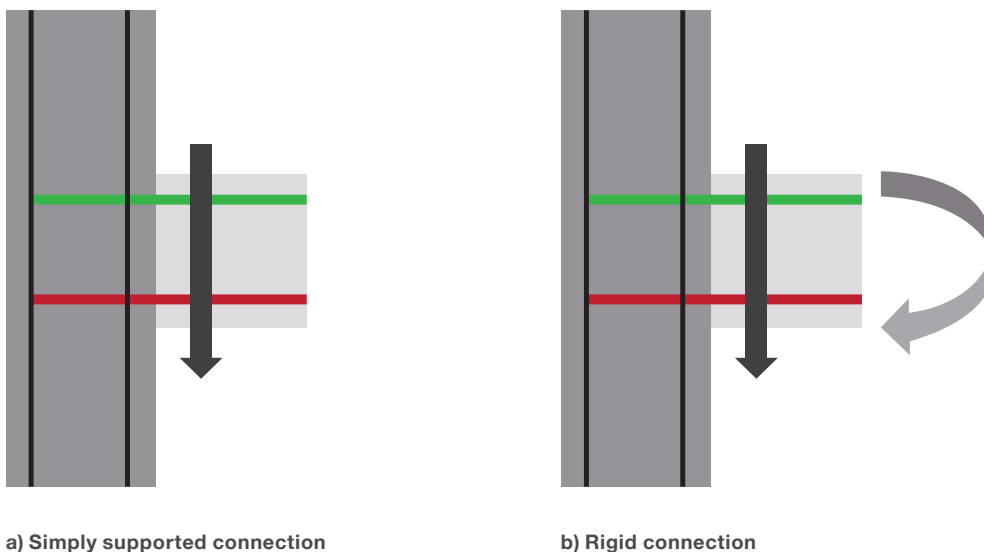

Fig. 6.1: Common end anchorage connections

### 6.2.1 Design for simply supported connections

Since the design force for simply supported connections is primarily shear, the anchorage length is derived following the provisions for curtailment of longitudinal tension reinforcement as per EC2-1-1 [1], section 9.2.1.3 and 9.2.1.4 for beams and 9.3.1.1 (4) for slab. The tension force in the bottom reinforcement to be anchored (see Fig. 6.2) is given by the following equation.

$$F_E = |V_{Ed}| \cdot a_l / z + N_{Ed} \quad \text{EC2-1-1, eq. (9.3)}$$

where:

$a_l = z \cdot (\cot\theta - \cot\alpha) / z$  for members with shear reinforcement (e.g., beams) with  $\theta$  and  $\alpha$  strut angle and inclination of shear reinforcement, respectively and  $z$  being the inner lever arm

$a_l = d$  for members without shear reinforcement (e.g., slabs), with  $d$  being the static height of the cross-section

Additionally, the shear transfer across the concrete cross-section is designed using section 6 of EC2-1-1 [1] (see [chapter 7](#) of this handbook for more details). Furthermore, the design engineer should consider the partial fixity of such connections as per the applicable design approaches or regional regulations/design standards (e.g., sections 9.2.1.2 (1) and 9.3.1.2 (2) of EC2-1-1 [1] for beam and slabs, respectively). This fixity arises out of the stiffness of the joint depending upon the relative stiffness of the cross-sections of the intersecting members, giving rise to a tension force in top rebars. Following the Anchor Theory of load bearing mechanism discussed in [chapter 4](#), the associated failure modes of rebar connection should be verified.

**Note:** Designer shall consider moment due to partial fixity in simply supported connections

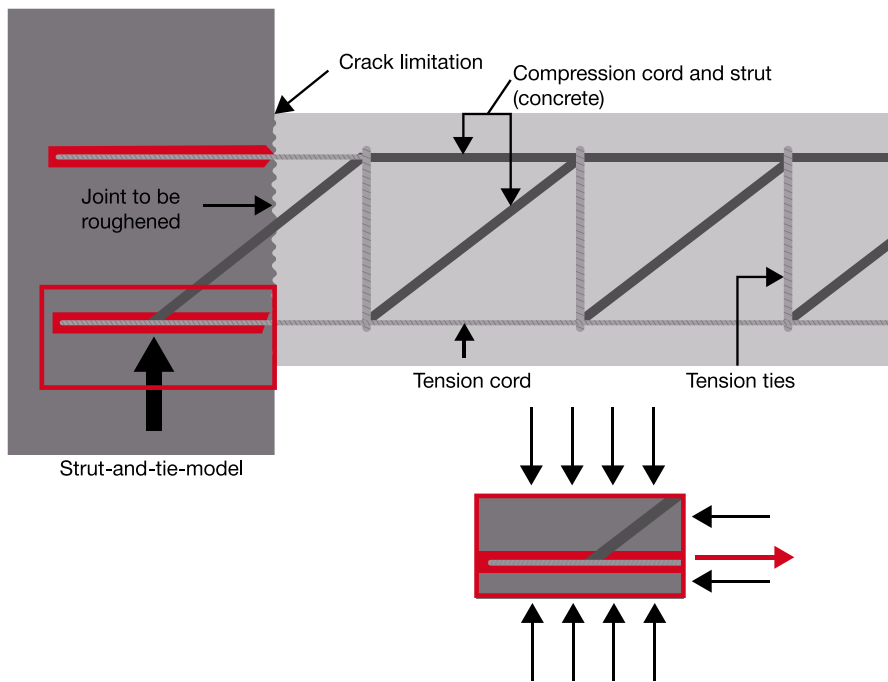

Fig. 6.2: Internal forces for simply supported connections

**Note:** Neglecting the partial fixity may lead to opening of a wide interface crack. A moment redistribution is usually possible (not in the case of cantilevers!), while no redistribution is applicable for shear forces. The impossibility of transferring shear forces through wide cracks may cause a brittle failure of the connection.

## 6.3 Design for rigid/moment-resisting connections

The design of the anchorage of rebars with axial forces arising out of design moments in rigid connections can be accomplished using two methods (strut-and-tie models and EOTA TR 069 [2]) as explained in the following sections.

### 6.3.1 Strut-and-tie model following the principles of Eurocode

EC2-1-1 [1] provides procedures for the development of strut-and-tie models to design reinforced concrete members, which can be suitably used for the design of system connections using post-installed rebars. A structural element is divided into B-region and D-region (see Fig. 6.3a). B-regions are parts of a structure in which Bernoulli's hypothesis of linear strain profiles applies and the region can be designed based on classical beam theory. D-regions are parts of a structure with a complex variation in strain. They include portions near abrupt changes in geometry (geometrical discontinuities) or concentrated forces (statistical discontinuities). The design of D-regions is complex and requires a clear understanding of force flow and hence in the strut and tie model, these internal forces are idealized as a truss, where the compression (struts) and tension (ties) members are determined in the region suitably. The reinforcement is provided in the determined tension areas while concrete compression strength is verified in the struts. The strut-and-tie model shall be chosen suitably resulting in small plastic deformations and economic reinforcement layout. The points of equilibrium where struts, ties, and concentrated forces intersect are denoted as nodes. The strut and tie model approach is treated extensively in the EC2-1-1 [1], section 6.5. Most post-installed reinforcing bar problems can be expressed with some variant of a C-C-T node, as shown in Fig. 6.3.

**Note:** The choice of a suitable S&T model for an application requires engineering judgement.

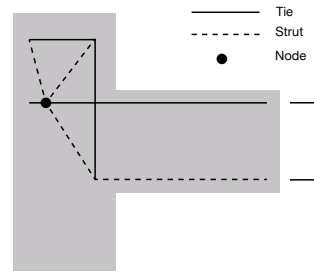
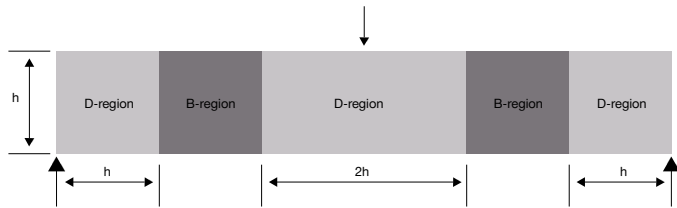

a) Idealized B & D regions in a Beam

b) Strut and tie model in a D-region

Fig. 6.3: Example of field of application of strut-and-tie models

In cooperation with the Technical University of Munich, Hilti performed a research program in order to provide a suitable strut and tie model in line with principles of EC2-1-1 [1] for rigid connections with straight post-installed rebars ([33] and [34]). The main difference between the standard cast-in solution and post-installed rebar solution is that the compression strut is anchored in the geometry of the bend of the bar (see Fig. 6.4a) rather rebar anchored in the bonding area of straight post-installed rebar (see Fig. 6.4b).

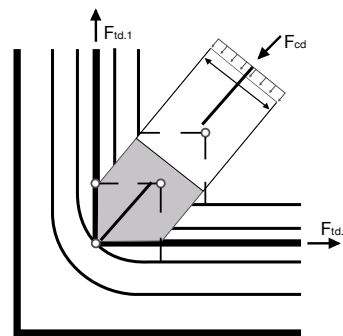
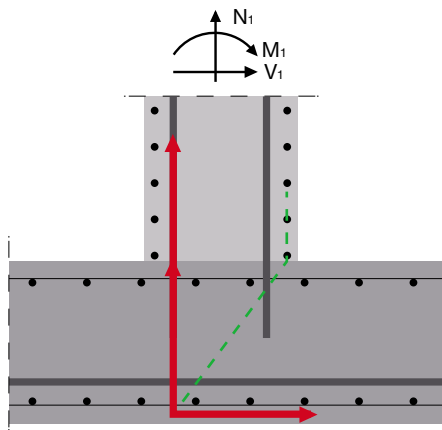

a) Cast-in bent rebar model

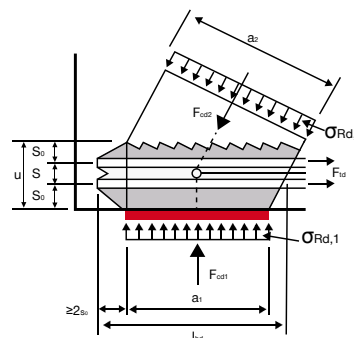
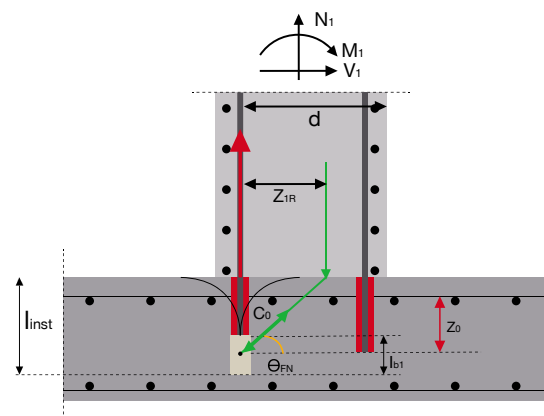

b) Post-installed straight rebar model

Fig. 6.4: Strut-and-tie model for moment resisting connections (red = tension, green = compression) according to EC2-1-1 [1]

**Hilti strut-and-tie model design steps**

A moment-resisting connection of post-installed rebar using a suitable strut-and-tie model depicted with ideal force distribution (see Fig. 6.5) is taken as an example here to present the design steps as follows:



1) Calculation of angle  $\theta$  between strut (5) and the interface between existing and new element (6)

as:

$$30^\circ \leq \theta \leq 60^\circ = \min \{60^\circ; \arctan (h_{ex} - (\max(30 \text{ mm}; 2\phi) - c - l_{bd}/2)/z_{1R})\}$$

where,

$h_{ex}$  is the thickness of the existing member

$z_{1R}$  is the reduced inner lever arm on the section of the new element (reduced to 85% in the case of opening moment in joints, and no reduction if it is closing moment)

**Note:** As denoted in the equation above, for a suitable strut-and-tie model, the strut angle  $\theta$  should always be  $30^\circ \leq \theta \leq 60^\circ$ . See [33] and [34] for the scientific background of these limitations.

2) Calculation of the design anchorage length,  $l_{bd,PIR}$  according to provisions mentioned earlier in this chapter

3) Calculation of post-installed rebar Installation length,  $l_{inst}$  in the existing member as:

$$l_{inst} = z_{1R} \cdot \tan\theta + \frac{l_{bd,PIR}}{2}$$

Check with maximum possible installation length  $l_{inst,max} = h_{ex} - \max(2 \cdot \phi; 30 \text{ mm})$

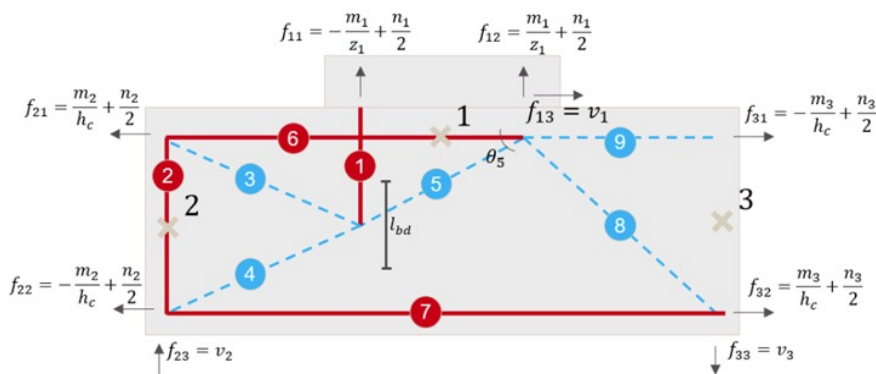

Fig. 6.5: Internal forces in strut and tie model for post-installed rebar application

$f_{xx}$  are internal forces;

$m_x$  are external moments;  $n_x$  are external axial forces

$z_1$  = Inner lever arm on the section of the new element

$z_2$  = Inner lever arm on the section of the existing element

4) Check for compression strut capacity:

- Determine the compression force on the strut (5) using the equation,

$$D_{c0} = \frac{\sigma_{sd} \cdot A_s}{\sin\theta}$$

where,  $A_s$  is the cross-sectional area of the rebars considered

- The maximum design compressive stress which can be applied

$$\sigma_{Rd,max} = v' \cdot k_2 \cdot \alpha_{cc} \cdot f_{ck} / \gamma_c$$

where,  $v' = 1 - f_{ck}/250$

EC2-1-1 (6.5.2 (2))

$$k_2 = 0.85$$

- Compression resistance of the strut (5)

$$D_{0,R} = \sigma_{Rd,max} \cdot l_{bd,PIR} \cdot w \cdot \cos\theta \geq D_{c0}$$

where,  $w$  = width of the section considered

- 5) Check for the internal tension force (6) to be resisted by the surface reinforcement of the existing member
- 6) Check for the shear resistance (splitting of concrete) in the disturbed/transition zone of existing member (i.e., in this model Fig. 6.5, strut 3-tie 6 and strut 4-tie 7)
- 7) In a typical strut and tie model for rigid/moment resisting connections, local passive confinement over the anchorage length is assumed. Since the rebar is anchored in the compression zone, concrete breakout failure mode does not occur and only bond failure (see Fig. 6.3b) needs to be verified.
- 8) The design anchorage length  $l_{bd,PIR}$  is calculated considering pullout failure of bond system, stress level in steel and corresponding bond strength value  $f_{bd,PIR}$  from the relevant ETA.

### 6.3.2 EOTA TR 069 design provisions

As discussed in chapter 3 of this Handbook, EOTA TR 069 [2] “*Design method for anchorages of post-installed reinforcing bars (rebar) with improved bond-splitting behavior as compared to EC2-1-1*” allows for the design for moment-resisting reinforced concrete connection applications of qualified post-installed rebar, without the need for a strut-and-tie model. Since the assumption of anchoring of the post-installed rebar in the compression zone is not required by the EOTA TR 069 [2], the potential concrete cone breakout is checked along with other failure modes. Furthermore, this design approach considers the product specific bond strength taken from the relevant ETA (see section 3.3.2).

The design resistances ( $R_d$ ) is the smallest of the following three failure modes:

$$R_d = \min ( N_{Rd,y}, N_{Rd,c} , N_{Rd,sp} ) \quad \text{EOTA TR 069, eq. (4.1)}$$

where,

$$N_{Rd} = N_{Rk} / \gamma_M$$

$N_{Rd,y}$  is steel yielding design resistance of post-installed rebar

$N_{Rd,c}$  is concrete cone breakout failure design resistance

$N_{Rd,sp}$  is bond-splitting failure design resistance of post-installed rebar

The partial safety factors given by EOTA TR 069 [2] in accordance with EC2-1-1 [1], EC2-4 [3], EC8-1 [9] and applicable national regulations for the calculation of design resistances are given in Table 6.2:

Table 6.2. Partial Safety factors for failure modes considered by EOTA TR 069 [2]

Parameter	Partial safety factor
Reinforcement steel yielding	$\gamma_{Ms} = 1.15$
Concrete cone breakout	$\gamma_{Mc} = \gamma_{inst} \cdot \gamma_c$ Where, $\gamma_{inst} \geq 1.0$ as per ETA $\gamma_c = 1.5$
Bond-splitting failure & pull-out failure	$\gamma_{Mp} = \gamma_{Msp} = \gamma_{Mc}$

**Note:** Concrete members connected using post-installed rebar systems must comply with the provisions of EC2-1-1 [1] for static & quasi-static loads and EC8-1 [9] for seismic loads and applicable national regulations.

#### Design resistance to yielding failure

The design resistance to yielding of post-installed steel rebar is given by the equation:

$$N_{Rk,y} = A_s \cdot f_{yk} \quad \text{EOTA TR 069, eq. (4.2)}$$

where,

$A_s$  is the cross-sectional area of post-installed rebars considered

$f_{yk}$  is the characteristic yield strength of steel

**Design resistance to concrete cone breakout failure**

For the calculation of the characteristic concrete breakout resistance ( $N_{Rk,c}$ ), the provisions of EC2-4 [3] are followed with a few exceptions (e.g., no limitation with maximum numbers of rebars given by the equation):

$$N_{Rk,c} = N_{Rk,c}^0 \cdot \frac{A_{c,N}}{A_{c,N}^0} \cdot \psi_{s,N} \cdot \psi_{ec,N} \cdot \psi_{re,N} \cdot \psi_{M,N} \tag{4.3}$$

EOTA TR 069, eq. (4.3)

$N_{Rk,c}^0$  is the characteristic resistance for single reinforcement post-installed in concrete and not influenced by any adjacent reinforcement or edge is given by the equation,

$$N_{Rk,c}^0 = k_1 \cdot \sqrt{f_{ck}} \cdot l_b^{1.5} \tag{4.4}$$

EOTA TR 069, eq. (4.4)

where,

$k_1$  is dependent on cracked or uncracked concrete whose value is given in the relevant ETA. If  $k_1$  value is not differently specified in the ETA, suggested value for cracked concrete is 7.7 and for uncracked concrete is 11 as per EOTA TR 069 [2].

$l_b$  is the anchorage length of the post-installed reinforcing bar.

All the other influencing factors of the equation are explained as follows:

- 1)  $\frac{A_{c,N}}{A_{c,N}^0}$  accounts for the geometric effect of axial spacing of reinforcement ( $s_{cr,N}$ ) and its edge distance ( $c$ ) (see Fig. 6.6)

where,

$A_{c,N} = s_{cr,N} \cdot s_{cr,N}$ , which is the reference projected area as per EOTA TR 069 [2], eq. (4.4),

with

$$s_{cr,N} = 3 \cdot l_b$$

$A_{c,N}^0$  is the actual project area of group of tensioned rebars as per EC2-4 [3]

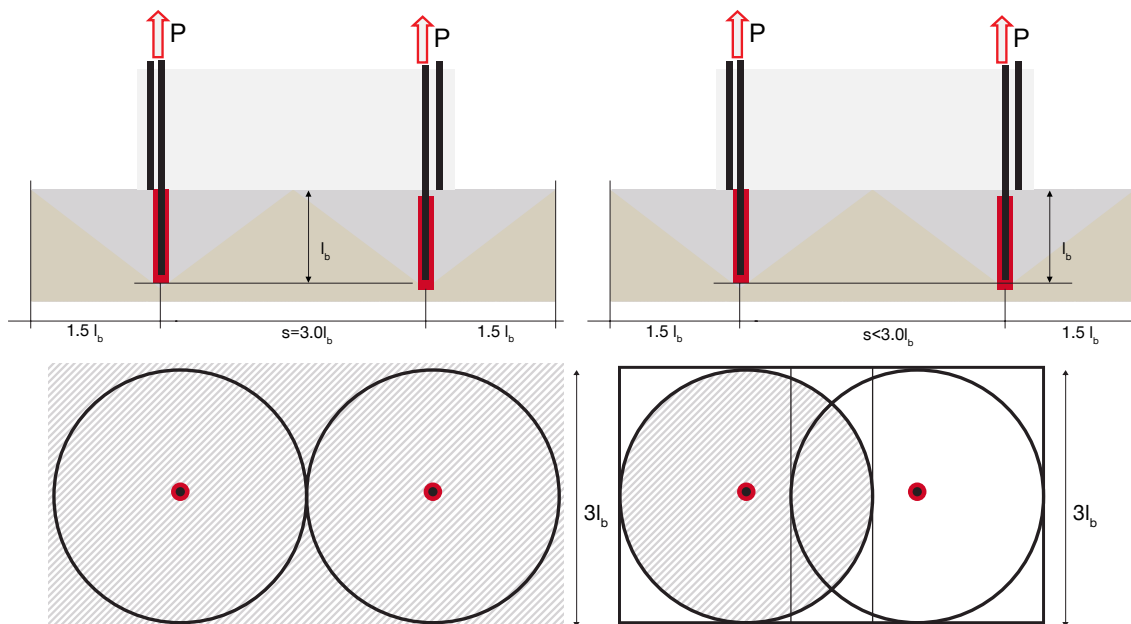

Fig. 6.6: Effect of projected area in concrete cone failure

- 2)  $\psi_{s,N}$  accounts for the disturbance of the distribution of stresses in the concrete due to the proximity of an edge of the concrete member (see Fig. 6.7), which is given by the equation  $\psi_{s,N} = 0.7 + 0.3 \cdot \frac{c}{c_{cr,N}} \leq 1.0$ , where  $c$  is the edge distance of rebar to closest edge and  $c_{cr,N}$  is given by the relevant ETA.

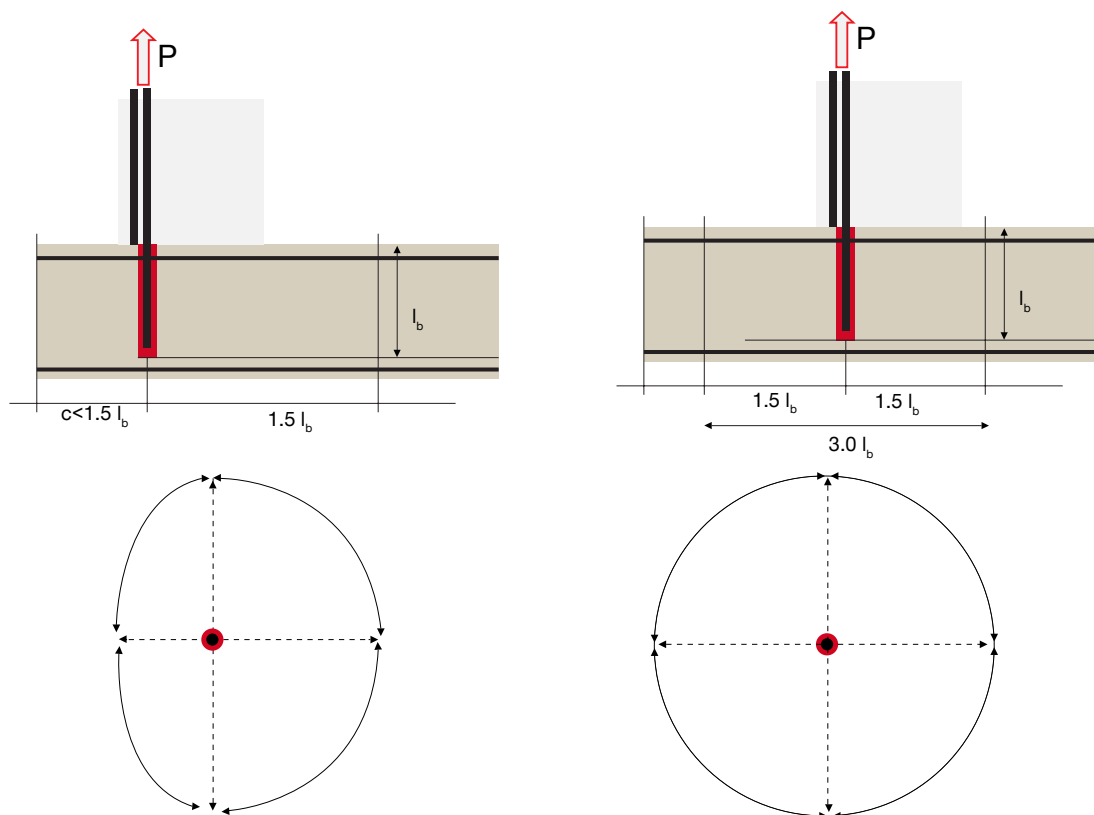

Fig. 6.7: Effect of proximity to concrete edge

- 3)  $\psi_{ec,N}$  accounts for the resulting load eccentricity ( $e_N$ ) with respect to centre of gravity of group of rebars (see Fig. 6.8), which is given by the equation  $\psi_{ec,N} = \frac{1}{1 + 2 \cdot \frac{e_N}{s_{cr,N}}} \leq 1.0$ .

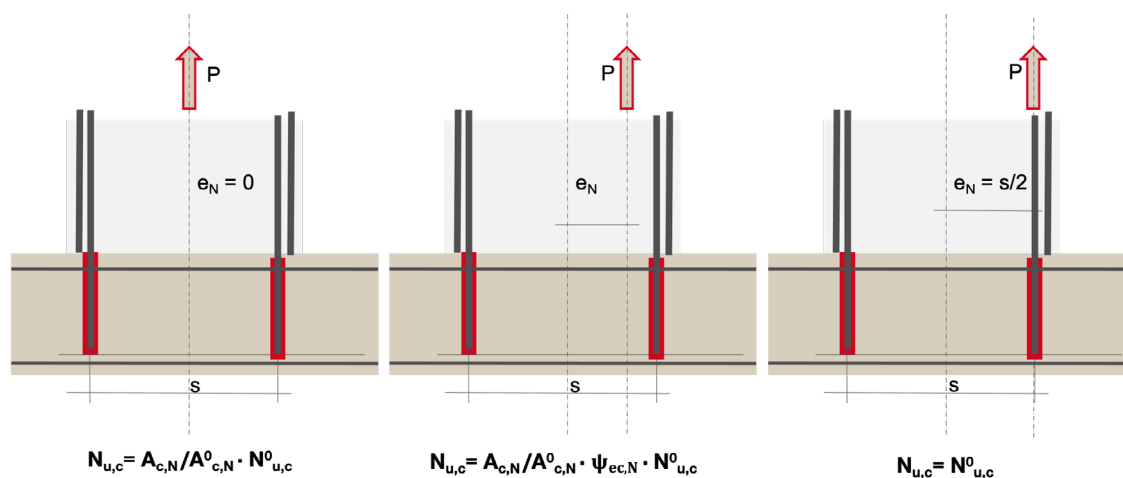

Fig. 6.8: Effect of eccentricity of load

- 4)  $\psi_{re,N}$  accounts for the effect of reduced resistance of post-installed rebars in dense existing reinforcement, which is given by the equation  $\psi_{re,N} = 0.5 + \frac{l_b}{200} \leq 1.0$ . This factor can be taken as 1.0 for the following:
- If the existing rebars (any diameter) are present at a spacing of  $\geq 150$  mm (or)
  - If the existing rebars with diameter  $\leq 10$  mm is present at a spacing of  $\geq 100$  mm
- This factor is always equal to 1.0, if the minimum anchorage length  $l_{b,min}$  according to EC2-1-1 [1] is kept.
- 5)  $\psi_{M,N}$  accounts for the effect of compression stresses resulting from the moment resisting actions on the concrete cone capacity, which is given by the equation  $\psi_{M,N} = 2.0 - \frac{z}{1.5 \cdot l_b} \geq 1.0$ , where  $z$  is the lever arm between the decoupled axial forces of applied moment in the cross-section of the connecting member (see Fig. 6.9). Refer to EOTA TR 069 [2] for the exceptional cases where the value of  $\psi_{M,N}$  is taken as 1.0.

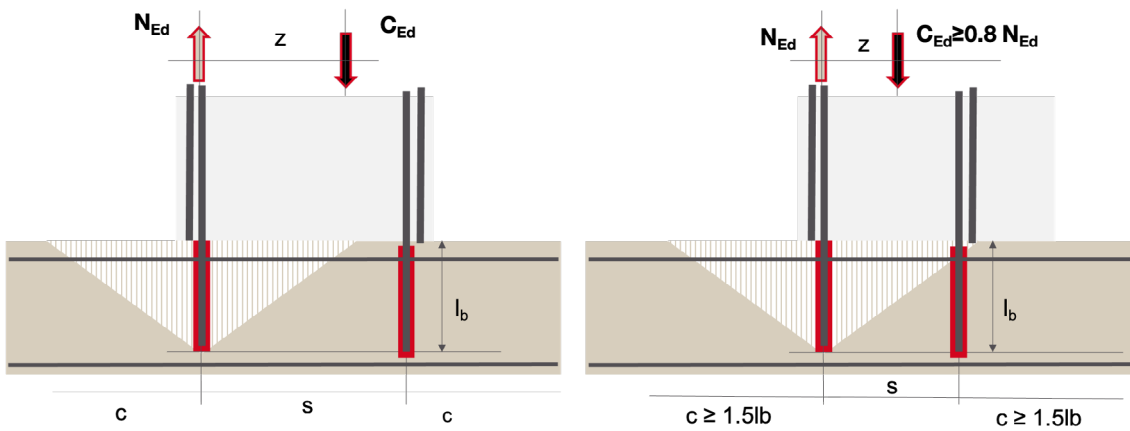

Fig. 6.9: Effect of compression stresses

### Design resistance to bond splitting failure

The characteristic bond-splitting resistance ( $N_{Rk,sp}$ ) is calculated using the equation based on fib Model code 2010 [35].

$$N_{Rk,sp} = \tau_{Rk,sp} \cdot l_b \cdot \phi \cdot \pi \quad (\text{for each tension rebar}) \quad \text{EOTA TR 069 eq. (4.10)}$$

$$\tau_{Rk,sp} = \eta_1 \cdot A_k \cdot \left(\frac{f_{ck}}{25}\right)^{sp1} \cdot \left(\frac{25}{\phi}\right)^{sp2} \cdot \left[\left(\frac{c_d}{\phi}\right)^{sp3} \cdot \left(\frac{c_{max}}{c_d}\right)^{sp4} + k_m \cdot K_{tr}\right] \cdot \left(\frac{7\phi}{l_b}\right)^{lb1} \cdot \Omega_{p,tr} \quad \text{EOTA TR 069, eq. (4.11a)}$$

$$\leq \tau_{Rk,ucr} \cdot \Omega_{cr,03} \quad (\text{or } \Omega_{p,tr}) \cdot \psi_{sus} \quad \text{for } 7\phi \leq l_b \leq 20\phi \quad \text{EOTA TR 069 eq. (4.11b)}$$

$$\leq \tau_{Rk,ucr} \cdot \left(\frac{20\phi}{l_b}\right)^{lb1} \cdot \Omega_{cr,03} \quad (\text{or } \Omega_{p,tr}) \cdot \psi_{sus} \quad \text{for } l_b > 20\phi \quad \text{EOTA TR 069 eq. (4.11c)}$$

where, all the other influencing factors of the equation are explained as follows:

$\eta_1$  is the coefficient related to quality of the bond conditions. Refer to the note in section 5.2.

$A_k$  is calculated as per EAD 332402 [10] and its value are to be taken from relevant ETA

$(f_{ck}/25)^{sp1}$  with sp1 from the ETA, the combined term accounts for the influence of concrete strength on the splitting strength of the mortar. Usually, the splitting strength increases with increasing concrete strength.

$(25/\phi)^{sp2}$  with sp2 from the ETA, the combined term accounts for the diameter-dependent size effect on the splitting bond strength. Typically, the splitting bond strength decreases with increasing rebar diameter.



$(c_d/\phi)^{sp3}$  with sp3 from the ETA, the combined term accounts for the influence of mortar on confinement from small concrete covers. Similar to EC2-1-1 [1], the minimum cover,  $c_d$ , is lowest of the cover to the nearest edge and half the clear spacing between the bars. The ETA sets the minimum concrete cover to be not less than  $2\phi$  and the design equation sets  $\phi$  as 12mm in the denominator when using bar sizes less than 12mm.

$(c_{max}/c_d)^{sp4}$  with sp4 from the ETA, the ratio of the largest ( $c_{max}$ ) to the smallest cover ( $c_d$ ) accounts for the influence of the mortar on confinement from large concrete covers.  $c_{max}$  is the largest of the cover to the farthest edge and half the bar spacing. Smaller ratios of  $c_{max}/c_d$  represent rebars positioned near corners where low confinement from cover reduces the splitting bond resistance. While the lower limit is 1.0, EOTA TR 069 [2] sets the upper limit of  $c_{max}/c_d$  as 3.5.

$(7\phi/l_b)^{lb1}$  the **splitting** bond strength degrades with increasing anchorage length, and the factor lb1 – from the mortar’s ETA – quantifies this degradation. A mortar with a lower lb1 factor is beneficial for deeper anchorages ( $l_b \gg 7\phi$ ).

$(20\phi/l_b)^{lb1}$  Similar to the reduction in splitting bond strength, pull-out bond strength (of the mortar) also declines in a non-linear manner with increasing anchorage length. This effect only becomes noticeable at anchorages beyond  $20\phi$  in combination with large concrete cover & spacings. The same factor lb1 from the mortar’s ETA further influences this degradation.

$\tau_{Rk,ucr}$  is the upper limit to bond-splitting resistance for uncracked concrete and value to be taken from relevant ETA.

$\Omega_{cr,03}$  depends on the sensitivity of the post-installed rebar system to cracks in concrete (up to 0.3 mm width) running along the bar axis, and its value to be taken from relevant ETA.

$\Omega_{p,tr}$  is a factor that represents the effect of transverse pressure perpendicular ( $\rho_{tr}$ ) to the axis of post-installed rebar in accordance with fib Model Code 2010 [35] and calculated using eq. (4.13) of EOTA TR 069 [2] as,

$$\Omega_{p,tr} = 1.0 - \frac{0.3 \cdot \rho_{tr}}{f_{ctm}} \quad \text{for } 0 \leq \rho_{tr} \leq f_{ctm} \text{ (tension)}$$

$$\Omega_{p,tr} = 1.0 - \tan h \left[ 0.2 \cdot \frac{\rho_{tr}}{0.1 \cdot f_{ctm}} \right] \quad \text{for } f_{ctm} \leq \rho_{tr} \leq 0 \text{ (compression)}$$

where,

$f_{cm}$  is the mean compressive strength of concrete

$f_{ctm}$  is the mean tensile strength of concrete

$\rho_{tr}$  is calculated as mean stress in the concrete at ultimate state (orthogonal to the bar axis) averaged over a volume around the bar with a diameter of  $3\phi$

$\psi_{sus}$  is the factor to consider sustained loads, calculated as per EN 1992-4 [3], EOTA TR 069 [2] and relevant ETA and calculated using eq. (4.14) of EOTA TR 069 [2] as

$$\psi_{sus} = 1 \quad \text{for } \alpha_{sus} \leq \psi_{sus}^0$$

$$\psi_{sus} = \psi_{sus}^0 + 1 - \alpha_{sus} \quad \text{for } \alpha_{sus} > \psi_{sus}^0$$

where,

$\psi_{sus}^0$  is product dependent factor based on influence of sustained loads as per relevant ETA

$\alpha_{sus}$  is the ratio between the value of sustained actions (permanent actions and permanent component of variable actions) and the value of total actions at ultimate limit state.

$c_d$  is  $\min\{c_x/2; c_x; c_y\}$  and  $c_{max}$  is  $\max\{c_x/2; c_x\}$  with the notations as in Fig. 6.10 below:

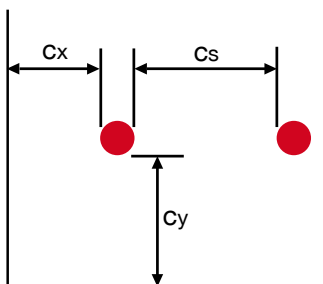

Fig. 6.10: Notation for rebar spacing and rebar cover as per fib model code 2010 [35]

$k_m$  is the factor for the effectiveness of transverse reinforcement (see Fig. 6.11), where its values are

- = 12 when the rebars are confined inside the bend of links passing around the bar of at least  $90^\circ$
- = 6 where a rebar is more than 125mm and more than 5 bar diameters from the nearest vertical leg of link crossing the splitting plane in approximately  $90^\circ$
- = 0 if splitting cracks would not intersect transverse reinforcement

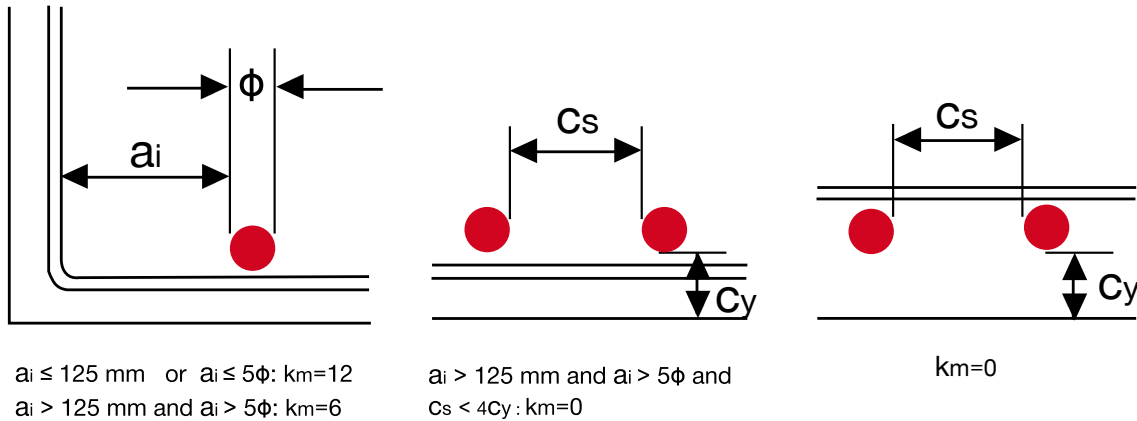

Fig. 6.11: Reduced effectiveness of links as per fib bulletin 72 [36]

$K_{tr}$  is the normalized ratio to consider the amount of transverse reinforcement crossing a potential splitting surface calculated as  $K_{tr} = (n_t \cdot A_{st}) / (n_b \cdot \phi \cdot s_b) \leq 0.05$

where,

$n_t$  is the number of legs of confining reinforcement crossing a potential splitting surface  
 $A_{st}$  is the cross-section area of one stirrup leg  
 $n_b$  is the number of anchored/lapped rebars in the potential splitting surface  
 $s_b$  is the spacing between the confining reinforcement

### Minimum anchorage length verification

The anchorage length ( $l_b$ ) calculated according to EOTA TR 069 [2] shall not be less than the minimum anchorage length ( $l_{b,min}$ ) calculated as per section 6.2.

### Design procedure and strategy

The three failure modes considered by the EOTA TR 069 [2] may be plotted in the following “hierarchy of strength” diagram (see Fig. 6.12) to visualize the most probable failure for a certain loading and anchorage length of the tension bars. This allows one to easily apply capacity design considerations, i.e., when feasible, allowing only steel yielding as decisive failure mode. The suitability of this approach has been validated by experimental evidence [22].

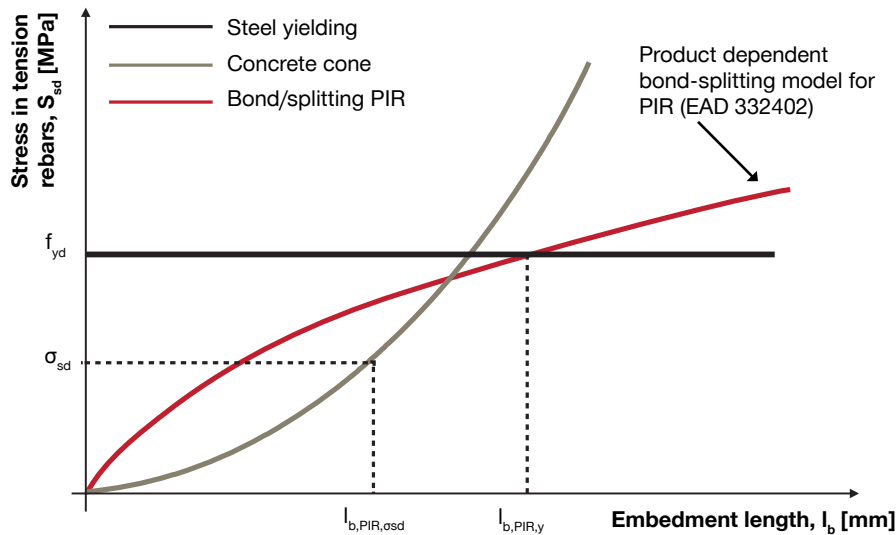

Fig. 6.12: Hierarchy of strength chart for EOTA TR 069 [2] design method

### Additional verifications for existing reinforced concrete member

The transfer of the loads between existing and new concrete members shall be verified in accordance with EC2-1-1 [1] and should consider all possible failure modes of the connection, e.g., the verification of the shear resistance of the existing member and the verification of the shear resistance of the nodal panel. Among the required design verifications, the local transfer of the forces from the tension post-installed rebars to the cast-in rebars in the existing element should be verified, e.g., according to EC2-4 [3], Annex A.

#### 6.3.3 Design according to EC2-1-1 principles with improved bond strength (Hilti method)

While the design provision for anchorage length calculations as per EC2-1-1 [1] is of direct and simple to use, either using the bond strength of the post-installed rebar system from the code prescription or ETA values, it still has a drawback in some applications due to geometrical limitations. The design of simply supported and moment resisting connections with the strut and tie model approach is only possible when the thickness of the existing member is sufficient to accommodate the design anchorage length. This is often because hooks or welded transverse reinforcement cannot be made with post-installed reinforcement.

The design methods according to EC2-1-1 [1] may be applied considering the full bond strength of the adhesive assessed according to the EAD 332402 [10] (i.e., same as that used for EOTA TR 069 [2] design) rather than the bond strength given by EC2-1-1 [1] (see Fig. 3.4).

The anchorage length calculations shown in section 6.2 are modified as follows:

$$l_{b,req,PIR} = (\phi/4) \cdot (\sigma_{sd} \cdot \gamma_{Mc} / \tau_{Rk,sp}) \geq l_{b,min,PIR} \quad \text{EC2-1-1 eq. (8.3) + EAD 332402}$$

where,

$\tau_{Rk,sp}$  calculated according to section 6.3.2.

The  $\alpha$ -factors according to EC2-1-1 [1] eq. (8.4) does not apply as the various influencing parameters are already considered in the formulation of  $\tau_{Rk,sp}$ .

**Note:** Detailing the reinforcement as per the relevant code and product ETA is required. Refer sect. 5.2.1 for post-installed reinforcement detailing rules and sect. 5.2.2 for durability requirements.

## 6.4 Design for seismic load actions

### 6.4.1 Design for seismic load actions as per Eurocode

For design of anchorage lengths of post-installed rebars under seismic actions, the provisions for static case of cast-in reinforcement remains valid according to EC8-1 [9] section 5.6.1. However, for post-installed rebars the suitability of the mortar to resist seismic (cyclic) loading has been checked in seismic assessments under various influencing parameters and values of design bond strength ( $f_{bd,seis}$ ) is provided in the respective ETAs which shall be used instead of ( $f_{bd,PIR}$ ) in the equations in section 6.2.

**Note:** These Eurocode provisions are valid only for simply supported conditions and not for strut-and-tie models.

**Note:** The minimum concrete cover shall be  $c_{min,seis}$  instead of  $c_{min}$  taken from the relevant ETA for seismic loads.

All the other coefficient values and design calculations for seismic remain the same as for static loading. Additional detailing rules of anchorages according to EC8-1 [9] and applicable national regulations shall be considered for post-installed rebar connections as well.

### 6.4.2 Design for seismic load actions as per EOTA TR 069

Currently, the only available design method for anchorage with post-installed rebars in moment resisting connections is provided by the EOTA TR 069 [2]. The decisive design resistance for seismic load conditions ( $R_{d,eq}$ ) should be the yielding of bar following the philosophy of seismic design according to EC8-1 [9] and it is given by the following equation:

$$R_{d,eq} = N_{Rd,y,eq} \leq \min(N_{Rd,c,eq}; N_{Rd,sp,eq}) \quad \text{EOTA TR 069 eq. (5.1)}$$

where,

$$N_{Rd} = N_{Rk} / \gamma_M$$

$N_{Rd,y,eq}$  is the seismic design resistance to yielding of post-installed rebars

$N_{Rd,c,eq}$  is the seismic design resistance of concrete cone breakout failure

$N_{Rd,sp,eq}$  is the seismic design resistance to bond-splitting failure of post-installed rebars

**Note:**  $N_{Rd,c,eq}$  or  $N_{Rd,sp,eq}$  may be an acceptable decisive failure mode, if the predicted plastic mechanism of the structural system is ductile at the demand level at which the post-installed rebar connection designed according to this EOTA TR 069 [2] method is still elastic.

#### Seismic design resistance to yielding failure of rebar

The seismic design resistance to yielding of post-installed steel rebar is given by the equation considering potential over-strength due to strain hardening:

$$N_{Rd,y,eq} = \gamma_{Rd} \cdot N_{Rk,y} \quad \text{EOTA TR 069 eq. (5.2)}$$

where,

$N_{Rk,y}$  is calculated as per static design provisions

$\gamma_{Rd} \geq 1.0$  is the factor accounting for possible overstrength due to steel strain hardening. The value of this factor is either 1.0 or 1.2 depending on seismic ductility class DCM or DCH respectively, as per provisions of EC8-1 [9] Cl. 5.6.2.2

#### Seismic design resistance to concrete cone breakout failure

The seismic design resistance to concrete cone breakout failure is modification of the static case:

$$N_{Rk,c,eq} = \alpha_{eq} \cdot N_{Rk,c} \quad \text{EOTA TR 069 eq. (5.3)}$$

where,

$\alpha_{eq} = 1.0$  if the crack width is  $\leq 0.3$  mm or  $0.85$  if crack width  $\geq 0.3$  mm

$N_{Rk,c}$  is calculated as per static design provisions

### Seismic design resistance to pull-out and bond-splitting failure

The design equations (4.11a, 4.11b and 4.11c) in static case gets modified for seismic design resistance:

$$\tau_{Rk,sp,eq} = \eta_1 \cdot \alpha_{eq,sp} \cdot A_k \cdot \left(\frac{f_{ck}}{25}\right)^{sp1} \cdot \left(\frac{25}{\phi}\right)^{sp2} \cdot \left[\left(\frac{c_d}{\phi}\right)^{sp3} \cdot \left(\frac{c_{max}}{c_d}\right)^{sp4} + k_m \cdot K_{tr}\right] \cdot \left(\frac{7\phi}{l_b}\right)^{lb1}$$

EOTA TR 069 eq. (5.4a)

$$\leq \tau_{Rk,ucr} \cdot \Omega_{cr,eq} \cdot \alpha_{eq,p} \quad \text{for } 7\phi \leq l_b \leq 20\phi \quad \text{EOTA TR 069 eq. (5.4b)}$$

$$\leq \tau_{Rk,ucr} \cdot \left(\frac{20\phi}{l_b}\right)^{lb1} \cdot \Omega_{cr,eq} \cdot \alpha_{eq,p} \quad \text{for } l_b > 20\phi \quad \text{EOTA TR 069 eq. (5.4c)}$$

where,

$\Omega_{cr,eq}$  depends on the crack width design assumptions and value is taken from relevant ETA

$\alpha_{eq,p}$  and  $\alpha_{eq,sp}$  are seismic reduction factors for pull-out and splitting failures taken from ETA

All other influencing factors are to be calculated as given in static design case.

The assumption related to the applicable crack width ranging between 0.3 mm and 0.8 mm it depends on the state of stress of the existing member. For example, smaller crack width can be expected to occur in members predominantly loaded in compression. On the other hand, larger crack width should be assumed for members that might deform significantly (i.e., high ductility). EOTA TR 069 [2] provides some guidance on this (see Table 6.3).

Table 6.3. Recommended assumptions for maximum design crack widths according to EOTA TR 069 [2]

Ductility class according to EN 1998-1	Behavior factor, q according to EN 1998-1	$L_b / h_{ex}$ [-]	Assumed crack width, $w_k$ [mm]	Comment
<b>DCL</b>	1.0	All	0.3	Static design applies
<b>DCM</b>	1.0 - 1.5	$\geq 0.8$	0.3	Seismic design applies
		$< 0.8$	0.5	
<b>DCM / DCH</b>	1.5 - 3.0	$\geq 0.8$	0.5	
		$< 0.8$	0.8	
<b>DCM / DCH</b>	$> 3.0$	$\geq 0.8$	0.8	
		$< 0.8$	Not covered by this TR	

## 6.5 Design for fire exposure

The principles of design for fire exposure are the same as discussed in section 5.4 for lap splices. However, for end anchorages/intersection connections, the temperature distribution usually varies along the embedment length of the rebar (see Fig. 6.13).

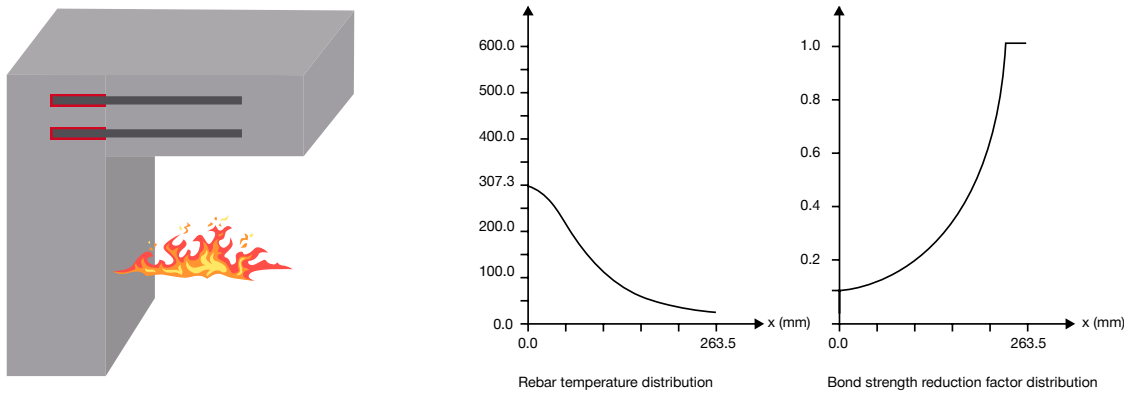

**Note:** These provisions for fire are only valid for simply supported connections and not for strut-and-tie models and EOTA TR 069

Fig. 6.13: Typical temperature distribution in end anchorage connection

### Design anchorage length calculation:

The design anchorage length can be calculated using the same design provisions for static load case, however the reduced bond strength capacity from the relevant ETA for fire ( $f_{bd,fi}$ ) shall be used instead of  $f_{bd}$ . The design bond strength under fire ( $f_{bd,fi}$ ) reduces with increasing temperature. This curve is then translated into the reduction factor  $k_{fi}(\theta(x))$  by calculating the ratio of the bond strength values to the reference value for cast-in-rebar for the respective concrete class (refer section 5.3 of this handbook).

The design bond stress at a position 'x' along the anchorage length under fire ( $f_{bd,fi}$ ) is calculated using the below equation,

$$f_{bd,fi} = k_{fi}(\theta(x)) \cdot f_{bd,PIR} \frac{\gamma_c}{\gamma_{c,fi}} \quad \text{EAD 330087}$$

where,

$k_{fi}(\theta(x))$  is the reduction factor at a position 'x' along the anchorage length dependent on exposure temperature taken from ETA.

$f_{bd,PIR}$  is the bond strength of post-installed rebar system

$\gamma_c$  is the factor of safety for concrete base material (usually 1.5)

$\gamma_{c,fi}$  is the material safety factor for concrete for fire condition is 1.0 (EC2-1-2 [8], sect. 2.3)

The fire bond resistance ( $N_{Rd,fi}$ ) for an assumed design anchorage length of post-installed rebars ( $l_{bd,fi}$ ) is given by the equation,

$$N_{Rd,fi} = \pi \cdot \phi \cdot \frac{\gamma_c}{\gamma_{c,fi}} \frac{f_{bd,fi}}{\alpha_2 \cdot \alpha_3 \cdot \alpha_5} \int_0^{l_{bd,fi}} k_{fi}(\theta(x)) dx$$

All the ' $\alpha$ ' coefficient values and their design calculations for seismic remains the same as for static and "x" is the distance in the axial direction of the rebar measured from the interface.

The fire bond resistance ( $N_{Rd,fi}$ ) calculated according to this integration method shall be not smaller than  $N_{Ed,fi}$ , requiring an iterative design process.

### Steel failure verification:

The design also considers the residual stress in the steel reinforcement in fire exposure and strength reduction factor  $k_s(\theta_{max})$

$$N_{Ed,fi} \leq F_{yd,fi} = k_s(\theta_{max}) \cdot A_s \cdot f_{y,k} / \gamma_{s,fi}$$

where,



$\gamma_{s,fi}$  is the material safety factor for steel for fire condition is 1.0

$A_s$  is the cross-sectional area of rebar(s)

$k_s(\theta_{max})$  is taken from EC2-1-2 [8]

The temperature  $\theta$  to calculate the reduction factors for mortar  $k_{fi}(\theta)$  and steel  $k_s(\theta)$  can also be taken from a suitable finite element model simulation (see section 5.4.4).

## 6.6 Design examples

### 6.6.1 Simply supported connection

Project requirement: provide post-installed reinforcing bars for a new simply supported slab/beam on a concrete structure as shown below.

#### Relevant project information

Geometry: Slab thickness,  $h = 250$  mm  
 Slab width,  $w = 1000$  mm  
 Slab length,  $l_n = 5000$  mm  
 Wall thickness,  $h_w = 300$  mm

Materials: Normal weight concrete C20/25  
 Reinforcing steel  $f_{yk} = 500$  N/mm<sup>2</sup>

Loading: Self weight + permanent loads,  $G_k = 7.5$  kN/m<sup>2</sup>  
 Variable loads,  $Q_k = 20$  kN/m<sup>2</sup>

Design working life: 50 years

Post-installed rebars parameters:

Drilling method/orientation: Rotary-hammer drilling / horizontal  
 Installation / in-service temp.: 20°C / 20°C (Long term) / 40°C (Short term)  
 Condition of base material: Dry  
 Post-installed rebar arrangement: Top/bottom cover  $c_{d,PIR} = 30$  mm  
 System choice: Hilti HIT-HY 200-R V3 (ETA-19/0600 [30])

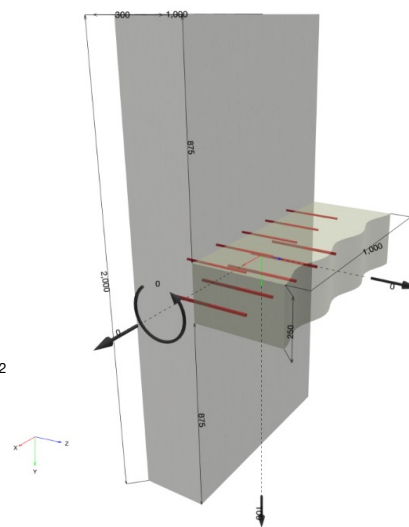

Fig. 6.14: Slab to Wall connection

#### Structural analysis (design actions)

$$S_{Ed} = (\gamma_G \cdot G_k + \gamma_Q \cdot Q_k) = (1.35 \cdot 7.5 + 1.5 \cdot 20) = 40.1 \text{ kN/m}^2$$

$$M_{Ed,m} = S_{Ed} \cdot l_n^2 / 8 = 125.3 \text{ kNm/m} \quad \text{Maximum bending moment (at mid span)}$$

$$V_{Ed,s} = S_{Ed} \cdot l_n / 2 = 100.3 \text{ kNm/m} \quad \text{Maximum shear (at support)}$$

#### Static design

##### Determination of action on bottom rebar layer

Additional tension force due to the shear load according to EN 1992-1-1:

$$\Delta F_{td} = F_{Ed} = |V_{Ed}| \cdot a_l / z \quad \text{EC2-1-1, eq. (9.3)}$$

$$a_l = d \quad \text{EC2-1-1, Sect. 9.3.1.1 (4)}$$

$$\Delta F_{td} = 100 \cdot d / z = 100 \cdot 213 / 192 = 110.9 \text{ kN}$$

#### Determination of action on top rebar layer

According to EC2-1-1 [1], Sect. 9.3.1.2 (3), where a partial fixity occurs along an edge of a slab, but is not considered in the analysis, the top reinforcement should be capable of resisting at least 25% of the maximum moment in the adjacent span. This case typically applies at end supports, where however, the moment to be resisted may be reduced to 15% of the maximum moment in the adjacent span.

$$M_{Ed,s} = 0.15 \cdot M_{Ed,s} = 0.15 \cdot 125.3 = 18.8 \text{ kNm/m}$$

**Note:** It is recommended to verify this assumption with appropriate structural analysis instruments, e.g., using the Hardy Cross method or numerical tools.

#### Design of bottom layer

Required bottom reinforcement at mid-span:

$$A_{s,rqd,m} = (M_{Ed,m} \cdot \gamma_s) / (z \cdot f_{yk}) = (125.3 \cdot 10^6 \cdot 1.15) / (192 \cdot 500) = 1501 \text{ mm}^2/\text{m}$$

$$\phi 14 / 100 \text{ mm} \rightarrow A_{s,prov,m} = 1539 \text{ mm}^2/\text{m} \quad \text{Provided reinforcement at mid-span}$$

Required post-installed reinforcement at support:

$$A_{s,min,s} = 0.5 \cdot A_{s,prov,m} = 751 \text{ mm}^2/\text{m} \quad \text{EC2-1-1, Sect. 9.3.1.2 (1)}$$

$$\phi 14 / 200 \text{ mm} \rightarrow A_{s,prov,s} = 770 \text{ mm}^2/\text{m} \quad \text{Provided reinforcement at support}$$

$$l_{b,rqd} = (\phi / 4) \cdot (\sigma_{sd} / f_{bd}) \quad \text{EC2-1-1, eq. (8.3)}$$

Where:

$$\sigma_{sd} = \Delta F_{td} / A_{s,prov} = 110.9 \cdot 10^3 / 770 = 144 \text{ MPa}$$

$$l_{b,PIR} = \alpha_2 \cdot \alpha_3 \cdot \alpha_5 \cdot l_{b,rqd,PIR} \geq l_{b,min,PIR} \quad \text{EC2-1-1, eq. (8.7) + EAD 330087}$$

$$l_{b,min,PIR} = \alpha_{lb} \cdot \max\{0.3 \cdot l_{b,rqd,PIR}; 10 \cdot \phi; 100\} \quad \text{EC2-1-1, eq. (8.11) + ETA-19/0600}$$

$$l_{b,min,PIR} = 1.0 \cdot \max\{66; 140; 100\} = 140 \text{ mm}$$

Where the  $\alpha$ -factors according to EC2-1-1 [1], Table 8.2 and considering that  $\alpha_1$  and  $\alpha_4$  are not applicable for post-installed reinforcement. In this case we have:

$$\alpha_2 = 1 - 0.15 \cdot (c_d - \phi) / \phi \geq 0.7 \quad \text{Influence of concrete cover}$$

$$= 1 - 0.15 \cdot (93 - 14) / 14 = 0.15 \rightarrow 0.7$$

$$\alpha_3 = 1.0 \quad \text{No transverse reinforcement}$$

$$\alpha_5 = 1.0 \quad \text{No transverse pressure}$$

$$l_{b,rqd,PIR} = (\phi / 4) \cdot (\sigma_{sd} / f_{bd,PIR}) \quad \text{EC2-1-1, eq. (8.3) + ETA-19/0600}$$

$$l_{b,rqd,PIR} = (14 / 4) \cdot (144 / 2.3) = 219 \text{ mm}$$

$$l_{b,PIR} = 0.7 \cdot 219 = 153 \text{ mm}$$

Design of top layer

$$A_{s,rqd,s} = (M_{Ed,s} \cdot \gamma_s) / (z \cdot f_{yk}) = (18.8 \cdot 10^6 \cdot 1.15) / (192 \cdot 500) = 225 \text{ mm}^2/m$$

$$A_{s,min} = (k_c \cdot k \cdot f_{ct,eff} \cdot A_{ct}) / f_{yk} \quad \text{EC2-1-1, Sect. 7.3.2 (2)}$$

$$A_{s,min} = (0.4 \cdot 1.0 \cdot 2.2 \cdot 125 \cdot 1000) / 500$$

$$A_{s,min} = 220 \text{ mm}^2/m$$

$$\phi 10/200 \text{ mm} \rightarrow A_{s,prov,m} = 392 \text{ mm}^2/m \quad \text{Provided at support}$$

$$\sigma_{sd} = (A_{s,rqd} / A_{s,prov}) \cdot (f_{yk} \cdot \gamma_s)$$

$$\sigma_{sd} = (225/392) \cdot (500 \cdot 1.15) = 250 \text{ MPa}$$

$$l_{b,rqd,PIR} = (\phi/4) \cdot (\sigma_{sd} / f_{bd,PIR}) \quad \text{EC2-1-1, eq. (8.3) + ETA-19/0600}$$

$$l_{b,rqd,PIR} = (10/4) \cdot (250/2.3) = 272 \text{ mm}$$

$$l_{bd,PIR} = \alpha_2 \cdot \alpha_3 \cdot \alpha_5 \cdot l_{b,rqd,PIR} \geq l_{b,min,PIR} \quad \text{EC2-1-1, eq. (8.7) + EAD 330087}$$

$$l_{bd,PIR} = 0.7 \cdot 1.0 \cdot 1.0 \cdot 272 = 190 \text{ mm} > 140 \text{ mm}$$

$$N_{Ed} \geq N_{Rd,c}$$

**Note:** The anchorage of the top bar is not confined. Therefore, a concrete breakout cannot be excluded and should be checked following the provisions of EOTA TR 069 [2] and EC2-4 [3].

$$N_{Rd,c} = N_{Rk,c} / \gamma_c \quad \text{EC2-4, tab. 7.1}$$

$$N_{Rk,c} = N_{Rk,c}^0 \cdot A_{c,N} / A_{c,N}^0 \cdot \psi_{s,N} \cdot \psi_{re,N} \cdot \psi_{ec,N} \cdot \psi_{M,N} \quad \text{EC2-4, eq. (7.1)}$$

$$N_{Rk,c}^0 = k_1 \cdot \sqrt{f_{ck}} \cdot l_{bd,PIR}^{1.5} \quad \text{EC2-1-1, eq. (7.2) with } h_{ef} = l_{bd,PIR}$$

$$N_{Rk,c}^0 = 7.7 \cdot \sqrt{20} \cdot 190^{1.5} = 90.2 \text{ kN} \quad \text{assumption of cracked concrete}$$

$$A_{c,N}^0 = 9 \cdot 190^2 = 324.9 \cdot 10^3 \text{ mm}^2 \quad \text{EN 1992-4, eq. (7.3)}$$

$$A_{c,N} = 1000 \cdot 3 \cdot 190 = 570 \cdot 10^3 \text{ mm}^2 \quad \text{EN 1992-4, Figure 7.4}$$

$$N_{Rk,c} = 90.2 \cdot 570 / 324.9 \cdot 1.0 \cdot 1.0 \cdot 1.0 \cdot 1.0 = 158.2 \text{ kN}$$

$$N_{Rd,c} = 158.2 / 1.5 = 105.5 \text{ kN}$$

$$N_{Ed} = \sigma_{sd} \cdot A_{s,prov,s} = 250 \cdot 392 = 98 \text{ kN} < N_{Rd,c} = 105.5 \text{ kN} \quad \text{verification fulfilled} \quad \checkmark$$

Fire design

The new connection shall fulfil fire exposure requirements. In this case a fire exposure class R 180 is required.

The loading on the connection may be reduced considering that we are dealing with an accidental loading combination:

$$V_{d,fi} = \eta_{fi} \cdot V_d = 0.7 \cdot 100 = 70 \text{ kNm}$$

$$\Delta F_{td,fi} = 70 \cdot d/z = 70 \cdot 213/192 = 77.6 \text{ kNm}$$

The material partial factors also change, being:  $\gamma_{s,fi} = \gamma_{c,fi} = 1.0$  EC2-1-2, Sect. 2.3

The temperature in the post-installed reinforcement decreases over the length with increasing distance from the interface between the existing and the new element. It can be calculated by means of finite elements method, e.g., using PROFIS Engineering. The temperature profile in the bottom layer of post-installed rebars (closer to the fire) is shown in Fig. 6.15.

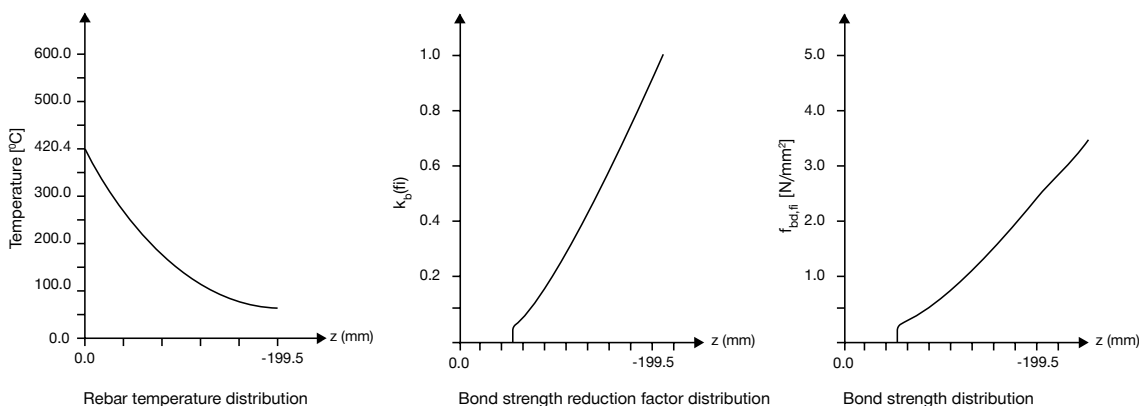

Fig. 6.15: Relevant parameters dependent on the fire exposure

### Steel verification

The steel verification under fire exposure shall be carried out considering the maximum temperature along the bar, i.e., 420 °C.

$$N_{Ed,fi} \leq F_{yd,fi} = k_s(\theta_{max}) \cdot A_s \cdot f_{y,k} / \gamma_{s,fi}$$

$$k_s(\theta_{max}) = 1.0 - 0.4 \cdot (\theta - 350) / 150 = 0.81$$

$$N_{Ed,fi} = \Delta F_{td,fi} / n = 77.6 / 5 = 15.6 \text{ kN} \leq 0.81 \cdot 154 \cdot 500 / 1.0 = 62.4 \text{ kN} \quad \text{Verification fulfilled} \checkmark$$

### Design of bottom layer – post-installed reinforcement

$$f_{bd,fi} = k_{fi}(\theta(x)) f_{bd,PIR} \frac{\gamma_c}{\gamma_{c,fi}} \quad \text{EAD 330087}$$

The bond strength can be calculated dividing the length of the bar embedded in the concrete into small parts at different temperature levels, i.e., conduct an integration (see section 6.5). The integration needs to be repeated iteratively to find the bond resistance  $N_{Rd,fi}$  that equalizes the external action  $N_{Ed,fi}$ . The use of a software solution like PROFIS Engineering offers significant advantages to save time for this design. PROFIS calculates an equivalent  $k_{fi} = 0.36$  (averaged value of the length).

$$f_{bd,fi} = k_{fi}(\theta(x)) \cdot f_{bd,PIR} \gamma_c / \gamma_{c,fi} \quad \text{ETA-20/0540}$$

$$f_{bd,fi} = 0.36 \cdot 2.3 \cdot 1.5 / 1.0 = 1.25 \text{ N/mm}^2$$

$$N_{Rd,fi} = \pi \cdot \phi \cdot f_{bd,fi} / (\alpha_2 \cdot \alpha_3 \cdot \alpha_5) \cdot l_{bd,PIR,fi}$$

$$l_{bd,PIR,fi} = (N_{Ed,fi} \cdot \alpha_2 \cdot \alpha_3 \cdot \alpha_5) / (\pi \cdot \phi \cdot f_{bd,fi}) = (15.6 \cdot 10^6 \cdot 0.7 \cdot 1.0 \cdot 1.0) / (\pi \cdot 14 \cdot 1.25) = 200 \text{ mm}$$

$l_{bd,PIR,fi} > l_{bd,PIR}$ , therefore, the required drilling length of the post-installed rebars in the bottom layer is equal to 200 mm.

### 6.6.2 Design example of end anchorage with strut-and-tie model

Project requirement: provide post-installed reinforcing bar for a new retaining wall for a reinforced concrete water tank.

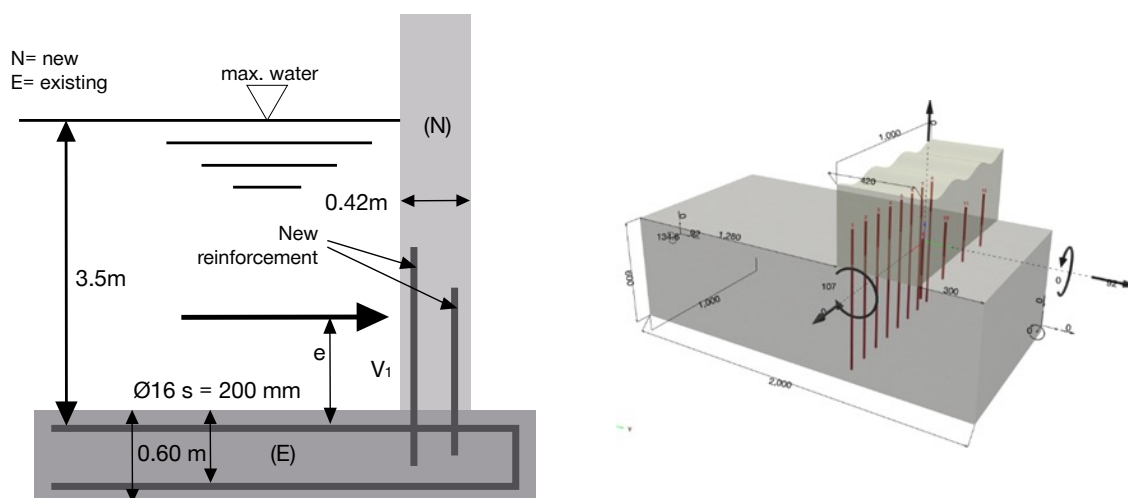

Fig. 6.16: Wall-to-slab moment connection

Relevant project information

Geometry: Thickness of the intersecting elements:  $h_1 = 420 \text{ mm}$ ,  $h_2 = h_3 = 600 \text{ mm}$   
 Static height of the intersecting elements:  $d_1 = 380 \text{ mm}$ ;  $d_2 = d_3 = 560 \text{ mm}$   
 $c_s = h_2 - d_2 = 40 \text{ mm}$

Material: Normal weight concrete C20/25 (new and existing elements)  
 Steel grade: 500 N/mm<sup>2</sup>

Loading: Hydrostatic water later pressure  
 Vertical loads are negligible

Design working life: 50 years

Post-installed rebars parameters:

Drilling method / orientation: Rotary-hammer drilling / vertical downwards

Installation / in-service temp.: 20°C / 20°C (Long term) / 40°C (Short term)

Condition of base material: Wet

Post-installed rebar arrangement: Top/bottom cover  $c_{d,PIR} = 40 \text{ mm}$

System choice: Hilti HIT-RE500 V4 (ETA-20/0540 [31])

Structural analysis (design actions)

$V_{1d} = \gamma_Q \cdot p \cdot h^2 / 2 = 1.5 \cdot 10 \cdot 3.5^2 / 2 = 92 \text{ kN/m}$  Acting shear force due to hydrostatic water pressure

$e = h / 3 = 3.5 / 3 = 1.17 \text{ m}$  Height of action of shear force

$M_{1d} = V_{1d} \cdot e = 92 \cdot 1.17 = 107 \text{ kNm/m}$  Bending moment at interface between slab and wall

Cross-section analysis

To determine the stress in the post-installed rebars a cross-section analysis following the principles of EC2-1-1 [1] is carried out (here using PROFIS Engineering). For this calculation, the contribution of the reinforcement in the compression zone is neglected.

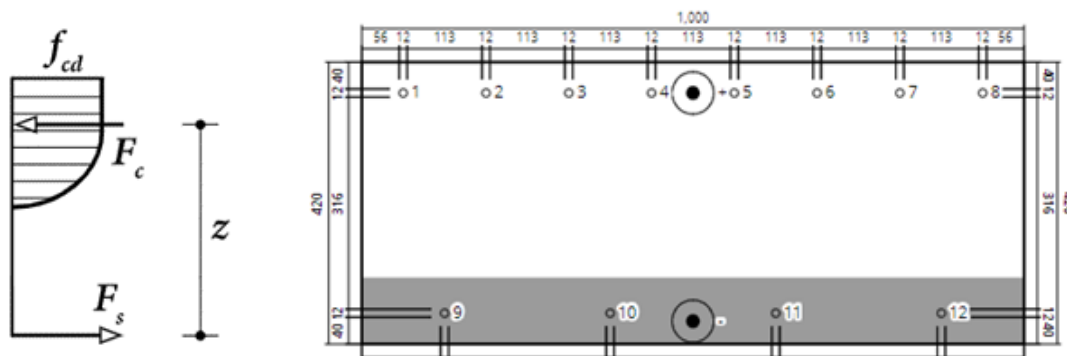

Fig. 6.17: Cross-section analysis

The inner lever arm,  $z = 340 \text{ mm}$  is derived.

$$z_{1R} = 0.85 \cdot 340 \text{ mm} = 289 \text{ mm}$$

Reduced lever arm for opening moment (see sect. 6.3.1)

$$F_{1sd} = M_{1d}/z_{1R} = 107 \cdot 10^3/289 = 378 \text{ kN/m}$$

Tension force in the post-installed rebars

$$A_{s1,rqd} = F_{1sd}/(f_{yk} \cdot \gamma_s) = 378 \cdot 10^3/435 = 869 \text{ mm}^2/\text{m}$$

$$\phi 12/125 \text{ mm} \rightarrow A_{s1,prov} = 905 \text{ mm}^2/\text{m}$$

Provided tension reinforcement

$$\sigma_{sd} = F_{1sd}/A_{s1,prov} = 378 \cdot 10^3/905 = 418 \text{ N/mm}^2/\text{m}$$

Design stress in the bars

The following strut-and-tie model is derived and can be calculated following the principles of trigonometry or using PROFIS Engineering.

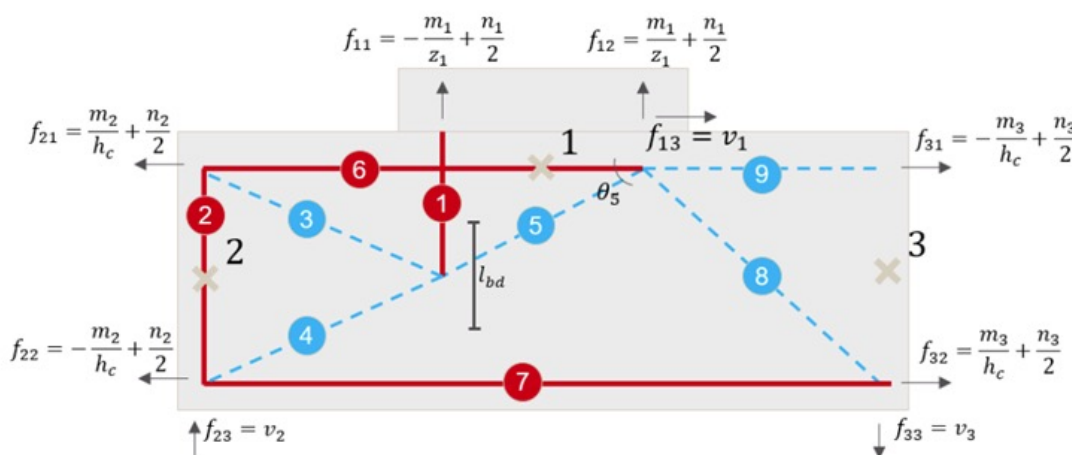

Fig. 6.18: Forces in strut-and-tie model



**Reactions**

	$f_i$ [kN]
f11	378.236
f12	-378.236
f13	92.000
f21	290.727
f22	-198.727
f23	0.000
f31	0.000
f32	0.000
f33	0.000

**Concrete struts**

	$f_i$ [kN]	$f_{iy}$ [kN]	$f_{iz}$ [kN]
3	-113.913	110.138	29.085
4	-200.844	198.727	29.085
5	-488.324	308.865	378.236
8	-0.000	-0.000	-0.000
9	-0.000	-0.000	0.000

**Rebar ties**

	$f_i$ [kN]	$A_{s,req,fi}$ [mm <sup>2</sup> ]	$A_{s,req,shear}$ [mm <sup>2</sup> ]
1	378.236	870	-
2	29.085	67	-
6	400.865	922	0
7	0.000	0	0

**Verification of tie no. 1:**

$$f_{db,PIR} = 2.3 \text{ N/mm}^2 \quad \text{ETA-20/0540}$$

$$l_{b,rqd,PIR} = (\phi/4) \cdot (\sigma_{sd}/f_{bd,PIR}) \quad \text{EC2-1-1, eq. (8.3) + ETA-20/0540}$$

$$l_{b,rqd,PIR} = (12/4) \cdot (418/2.3) = 545 \text{ mm}$$

$$l_{bd,PIR} = \alpha_2 \cdot \alpha_3 \cdot \alpha_5 \cdot l_{b,rqd,PIR} \geq l_{b,min,PIR} \quad \text{EC2-1-1, eq. (8.7) + EAD 330087}$$

$$l_{b,min,PIR} = \alpha_{lb} \cdot \max\{0.3 \cdot l_{b,rqd,PIR}; 10 \cdot \phi; 100\} \quad \text{EC2-1-1, eq. (8.11) + ETA-19/0600}$$

$$l_{b,min,PIR} = 1.0 \cdot \max\{164; 120; 100\} = 164 \text{ mm}$$

$$l_{bd,PIR} = 0.7 \cdot 1.0 \cdot 1.0 \cdot 545 = 382 \text{ mm} > 164 \text{ mm}$$

**Drilling length**

$$l_{v,PIR} = l_1 + l_{bd}/2 + c_s$$

$$l_1 = z_{1R} \cdot \tan\theta$$

$$\theta = \min\{60^\circ; \arctan((h_2 - \max(30 \text{ mm}; 2 \cdot \phi) - c_s - l_{b1}/2)/z_{1R})\}$$

$$\theta = \min\{60^\circ; \arctan((600 - \max(30; 2 \cdot 12) - 40 - 382/2)/289)\} = 49.6^\circ > 30^\circ \rightarrow \text{ok!}$$

$$l_{v,PIR} = 289 \cdot \tan(49.6^\circ) + 382/2 + 40 = 571 \text{ mm}$$

**Verification of strut no. 5**

$$\sigma_5 \leq \sigma_{Rd,max}$$

$$\sigma_5 = F_5 / (l_{bd} \cdot \cos(\theta)) = 488.3 \cdot 10^3 / (382 \cdot \cos(49.6^\circ)) = 1.97 \text{ N/mm}^2$$

$$\sigma_{Rd,max} = k_2 \cdot v' \cdot f_{cd} \quad \text{EC2-1-1, eq. (6.61)}$$

$$k_2 = 0.85 \quad \text{EC2-1-1, sect. 6.5.4 (4b)}$$

$$v' = 1 - f_{ck}/250 = 1 - 20/250 = 0.92 \quad \text{EC2-1-1, eq. (6.57N)}$$

$$f_{cd} \leq \alpha_{cc} \cdot f_{ck}/\gamma_c = 0.85 \cdot 20/1.5 = 13.33 \text{ N/mm}^2 \quad \text{EC2-1-1, eq. (3.15)}$$

$$\sigma_5 = 1.97 < 0.85 \cdot 0.92 \cdot 13.33 = 10.4 \text{ N/mm}^2 \quad \text{Verification fulfilled } \checkmark$$

The shear capacity in the disturbed zones (strut 3 and tie 6) and (strut 4 and tie 7) can be calculated following the provisions of EC2-1-1 [1], Section 6.2.2 and considering the following actions:

Strut 3 and tie 6:  $V_{Ed} = 29.1 \text{ kN}$  and  $F_{Ed} = 400.9 \text{ kN}$

Strut 4 and tie 7:  $V_{Ed} = 29.1 \text{ kN}$  and  $F_{Ed} = 0 \text{ kN}$

**Note:** The designer should check that sufficient reinforcement in the base material is present at the locations, where the ties are assumed according to this strut-and-tie model.

#### Possible optimization of the design using the strut-and-tie method

Option 1: consider the minimum allowed strut angle  $\theta = 30^\circ$

$$l_{v,PIR} = 289 \cdot \tan(30^\circ) + 382/2 + 40 = 398 \text{ mm}$$

While the verification of the tie 1 is unchanged, the verification of the strut 5 and the shear verification in the disturbed zones (strut 3 and tie 6) and (strut 4 and tie 7) are modified to consider the following actions:

$$\sigma_5 = F_5/(l_{bd} \cdot \cos(\theta)) = 756.5/(382 \cdot \cos(30^\circ)) = 2.29 \text{ N/mm}^2 < 10.4 \text{ N/mm}^2 \quad \text{Verification fulfilled } \checkmark$$

Strut 3 and tie 6:  $V_{Ed} = 56.8 \text{ kN}$  and  $F_{Ed} = 747.1 \text{ kN}$

Strut 4 and tie 7:  $V_{Ed} = 56.8 \text{ kN}$  and  $F_{Ed} = 0 \text{ kN}$

**Note:** The reduction of assumed strut angle  $\theta$  allows the reduction of the anchorage length. However, it should be noted that the shear forces acting in the existing member significantly increase (in this case from 400.9 kN to 747.1 kN).

Option 2: consider the bond strength as per design according to EOTA TR 069 [2] and minimum allowed strut angle  $\theta=30^\circ$

$$l_{v,PIR} = 289 \cdot \tan(30^\circ) + 382/2 + 40 = 398 \text{ mm}$$

$$l_b = \phi/4 \cdot \sigma_{sd}/\tau_{Rd,sp}$$

$$\tau_{Rd,sp} = \tau_{Rk,sp}/\gamma_c$$

$$\tau_{Rk,sp} = \eta_1 \cdot A_k \cdot \left(\frac{f_{ck}}{25}\right)^{sp1} \cdot \left(\frac{25}{\phi}\right)^{sp2} \cdot \left[\left(\frac{c_d}{\phi}\right)^{sp3} \cdot \left(\frac{c_{max}}{c_d}\right)^{sp4} + k_m \cdot k_{tr}\right] \cdot \left(\frac{7 \cdot \phi}{l_b}\right)^{lb1} \quad \text{EOTA TR069, eq. (4.11a)}$$

$$\tau_{Rk,sp} \leq \tau_{Rk,ucr} \quad \text{for } l_b \leq 20 \cdot \phi \quad \text{EOTA TR069, eq. (4.11b)}$$

$$\tau_{Rk,sp} \leq \tau_{Rk,ucr} \left(\frac{20 \cdot \phi}{l_b}\right)^{lb1} \quad \text{for } l_b > 20 \cdot \phi \quad \text{EOTA TR069, eq. (4.11c)}$$

Considering the product dependent parameters from the ETA-20/0539 [37] and an iterative process to equalize the bond strength of the bar with the external action, we derive:

$$\tau_{Rd,sp} = 6.48 \text{ N/mm}^2$$

$$l_b = 12/4 \cdot 418/6.48 = 194 \text{ mm}$$

$$l_{v,PIR} = 289 \cdot \tan(30^\circ) + 194/2 + 40 = 304 \text{ mm}$$

While the verification of the tie 1 is unchanged, the verification of the strut 5 and the shear verification in the disturbed zones (strut 3 and tie 6) and (strut 4 and tie 7) are modified to consider the following actions:

$$\sigma_5 = F_5 / (l_b \cdot \cos(\theta)) = 756.5 / (194 \cdot \cos(30^\circ)) = 4.50 \text{ N/mm}^2 < 10.4 \text{ N/mm}^2 \quad \text{Verification fulfilled } \checkmark$$

Strut 3 and tie 6:  $V_{Ed} = 56.8 \text{ kN}$  and  $F_{Ed} = 747.1 \text{ kN}$

Strut 4 and tie 7:  $V_{Ed} = 56.8 \text{ kN}$  and  $F_{Ed} = 0 \text{ kN}$

For this design option the following drilling length is required:

$$l_{v,PIR} = 289 \cdot \tan(30^\circ) + 194/2 + 40 = 304 \text{ mm}$$

Post-installed reinforcement in the compression zone

In the compression zone a post-installed reinforcement in form of  $\phi 12/250 \text{ mm}$  is provided. Since the reinforcement in compression zone has been neglected in the section analysis, it should be anchored following the provisions for minimum anchorage length in tension of EC2-1-1 [1].

$$l_{b,min,PIR} > \alpha_{lb} \cdot \max\{0.3 \cdot l_{b,rqd,PIR}; 10 \cdot \phi; 100 \text{ mm}\} \quad \text{EC2-1-1, eq. (8.6) + ETA-20/0540}$$

$$l_{b,min,PIR} > 1.0 \cdot \max\{0.3 \cdot 0; 10 \cdot 12; 100 \text{ mm}\} = 120 \text{ mm}$$

**6.6.3 Design example of end anchorage with EOTA TR 069**

Project requirement: Provide post-installed reinforcing bars to install a new moment resisting beam in an existing wall.

Relevant project information

Geometry:

Wall thickness,  $h = 350 \text{ mm}$   
 Beam section,  $300 \times 300 \text{ mm}^2$

Material:

Normal weight concrete C30/37  
 Reinforcing steel  $f_{yk} = 500 \text{ N/mm}^2$

Loading:

$V_{Sd} = 50 \text{ kN}$   
 $M_{Sd} = 30 \text{ kNm}$

Design working life:

50 years

Loading cases:

Static and seismic

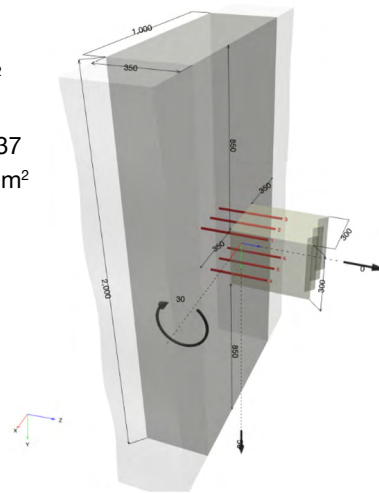

Fig. 6.19: Beam to Wall connection

Post-installed rebars parameters:

Drilling method / orientation:

Hammer drilling / horizontal

Installation / in-service temp.:

20°C / 20°C (Long term) / 40°C (Short term)

Condition of base material:

Wet / uncracked

Design working life:

50 years

Post-installed rebar arrangement:

Top/bottom cover  $c_{d,PIR} = 30 \text{ mm}$

System choice:

Hilti HIT-RE 500 V4 (ETA-20/0539 [37])

As explained in section 6.3.2, the design anchorage length according to EOTA TR 069 [2] is the maximum length required to resist the design actions calculated for the failure modes of concrete breakout and bond-splitting, provided that the steel yielding strength is sufficient to resist the imposed stresses. Since the bond-splitting resistance is a function of the drilling length, the solution to this problem may be found either through a numerical iterative process (e.g., with PROFIS Engineering) or with a graphic approach. This second method is used for this example.

### Cross-section analysis

To determine the stress in the post-installed rebars a cross-section analysis following the principles of EC2-1-1 [1] is carried out (here using PROFIS Engineering). The reinforcement in the compression zone is not taken into account.

The inner lever arm,  $z = 240$  mm is derived for the applied bending moment (static load case).

The inner lever arm,  $z = 251$  mm is derived for the plastic bending moment (seismic load case).

### Static design

#### Post-installed reinforcement in the tension zone (top layer)

The force per bar in the tension zone is:

$$N_{Ed} = M_{Sd} / (n \cdot z) = 30 \cdot 10^3 / (3 \cdot 240) = 41.7 \text{ kN} \text{ (125.1 kN for the entire layer)}$$

The graphic representation shown in Fig. 6.20 indicates that a drilling length equal to 168 mm of the post-installed rebars is required to anchor the static design forces. In the following, the calculations for concrete cone breakout and bond-splitting are shown.

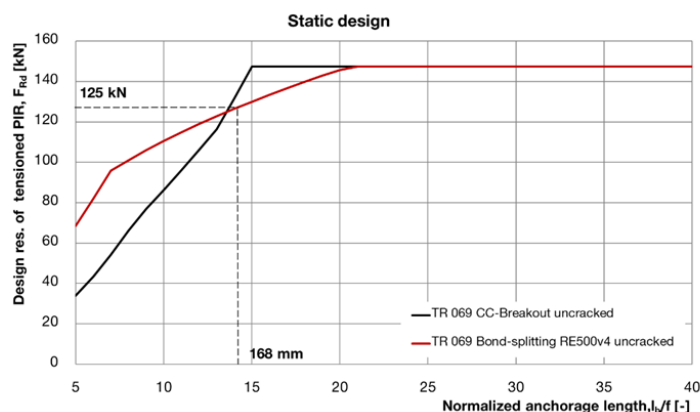

Fig. 6.20: Graphic representation of the required anchorage length for the static load case

#### Steel yielding verification:

$$N_{Rd,y} = A_s \cdot f_{yk} / \gamma_s = 113 \cdot 500 / 1.15 = 49.1 \text{ kN} \quad \text{EOTA TR 069, eq. (4.2)}$$

$$N_{Rd,y} = 49.1 \text{ kN} > N_{Ed} = 42.0 \text{ kN} \quad \text{Verification fulfilled } \checkmark$$

#### Concrete cone breakout verification:

$$N_{Rd,c} = N_{Rk,c}^0 \cdot \frac{A_{c,N}}{A_{c,N}^0} \cdot \psi_{s,N} \cdot \psi_{ec,N} \cdot \psi_{re,N} \cdot \psi_{M,N} / \gamma_{Mc} \geq N_{Ed} \quad \text{EOTA TR 069, eq. (4.3)}$$

$$N_{Rk,c}^0 = k_1 \cdot \sqrt{f_{ck}} \cdot l_b^{1.5} = 11.0 \cdot \sqrt{30} \cdot 168^{1.5} = 131.2 \text{ kN} \quad \text{EOTA TR 069, eq. (4.4)}$$

$$A_{c,N}^0 = s_{cr,N} \cdot s_{cr,N} = 9 \cdot l_b^2 = 9 \cdot 168^2 = 254,016 \text{ mm}^2 \quad \text{EOTA TR 069, eq. (4.5)}$$

$$A_{c,N} = 3 \cdot l_b \cdot (2 \cdot 102 + 2 \cdot \phi + 3 \cdot l_b) = 3 \cdot 168 \cdot (2 \cdot 102 + 2 \cdot 12 + 3 \cdot 168) = 368,928 \text{ mm}^2$$

$$\psi_{s,N} = 1.0 \quad \text{no influence of edges} \quad \text{EOTA TR 069, sect. 4.3 (3)}$$

$$\psi_{ec,N} = 1.0 \quad \text{no eccentricity} \quad \text{EOTA TR 069, sect. 4.3 (4)}$$

$$\psi_{re,N} = 1.0 \quad \text{no negative influence of surface reinforcement} \quad \text{EOTA TR 069, sect. 4.3 (5)}$$

$$\psi_{M,N} = 2 - z/(1.5 \cdot l_b) = 2 - 240/(1.5 \cdot 168) = 1.05 \quad \text{EOTA TR 069, eq. (4.9)}$$

$$N_{Rd,c} = 131.2 \cdot 368,928/254,016 \cdot 1.0 \cdot 1.0 \cdot 1.0 \cdot 1.05/1.5 = 133.4 \text{ kN} > 125.1 \text{ kN} \quad \text{Verification fulfilled} \checkmark$$

#### Bond-splitting verification:

$$\tau_{Rk,sp} = \eta_1 \cdot A_k \cdot \left(\frac{f_{ck}}{25}\right)^{sp1} \cdot \left(\frac{25}{\phi}\right)^{sp2} \cdot \left[\left(\frac{c_d}{\phi}\right)^{sp3} \cdot \left(\frac{c_{max}}{c_d}\right)^{sp4}\right] \cdot \left(\frac{7\phi}{l_b}\right)^{lb1} \quad \text{EOTA TR 069 eq. (4.11a) + ETA-20/0539}$$

$$\tau_{Rk,sp} = 1.0 \cdot 4.4 \cdot \left(\frac{30}{25}\right)^{0.29} \cdot \left(\frac{25}{12}\right)^{0.27} \cdot \left[\left(\frac{51}{12}\right)^{0.68}\right] \cdot \left(\frac{7 \cdot 12}{168}\right)^{0.60} = 10.0 \text{ N/mm}^2$$

$$\tau_{Rk,sp} \leq \tau_{Rk,ucr} \cdot (f_{ck}/20)^m = 15 \cdot (30/20)^{0.1} = 15.6 \text{ N/mm}^2 \quad \text{splitting is decisive}$$

$$N_{Rd,sp} = \tau_{Rk,sp} \cdot l_b \cdot \phi \cdot \pi/\gamma_{Mc} = 10.0 \cdot 12 \cdot 168 \cdot \pi/1.5 = 41.7 \text{ kN} > 42.0 \text{ kN} \quad \text{Verification fulfilled} \checkmark$$

#### Post-installed reinforcement in the compression zone (bottom layer)

Since the reinforcement in compression zone has been neglected in the section analysis, it should be anchored following the provisions for minimum anchorage length in tension of EC2-1-1 [1].

$$l_{b,min,PIR} > \alpha_{lb} \cdot \max\{0.3 \cdot l_{b,rqd,PIR}; 10 \cdot \phi; 100 \text{ mm}\} \quad \text{EC2-1-1, eq. (8.6) + ETA-20/0540}$$

$$l_{b,min,PIR} > 1.0 \cdot \max\{0.3 \cdot 0; 10 \cdot 12; 100 \text{ mm}\} = 120 \text{ mm}$$

#### Seismic design

##### Post-installed reinforcement in the tension zone (top layer)

The design verification for seismic loading, is carried out considering the tension force in the post-installed rebars corresponding to the plastic moment of the cross-section of the beam, i.e.,

$$N_{Ed,eq} = A_s \cdot f_{yd} = 113 \cdot 500 = 49.1 \text{ kN}$$

For this connection a Ductility Class Medium (DCM) with a behavior factor equal to 1.5 according to EC8-1 [9] is assumed. It is assumed that the ratio  $l_b/h$  will be not smaller than 0.8. Therefore, following the recommendation of EOTA TR 069 [2], Table 3.6.1, a crack width of  $w_k = 0.5 \text{ mm}$  is assumed. A factor  $\gamma_{Rd} = 1.0$  is chosen, since no significant plastic deformation is expected.

The graphic representation shown in Fig. 6.21 indicates that a drilling length equal to 288 mm of the post-installed rebars is required to anchor for resistance against seismic actions. In the following, the calculations for concrete cone breakout and bond-splitting are shown.

##### Concrete cone breakout verification:

$$N_{Rd,c,eq} = \alpha_{eq} \cdot N_{Rk,c}/\gamma_{Mc} \geq N_{Ed,eq} \quad \text{EOTA TR 069, eq. (5.3)}$$

$$N_{Rk,c}^0 = k_1 \cdot \sqrt{f_{ck}} \cdot l_b^{1.5} = 7.7 \cdot \sqrt{30} \cdot 288^{1.5} = 206.5 \text{ kN} \quad \text{EOTA TR 069, eq. (4.4)}$$

$$A_{c,N}^0 = s_{cr,N} \cdot s_{cr,N} = 9 \cdot l_b^2 = 9 \cdot 288^2 = 746,496 \text{ mm}^2 \quad \text{EOTA TR 069, eq. (4.5)}$$

$$A_{c,N} = 3 \cdot l_b \cdot (2 \cdot 102 + 2 \cdot \phi + 3 \cdot l_b) = 3 \cdot 288 \cdot (2 \cdot 102 + 2 \cdot 12 + 3 \cdot 288) = 943,488 \text{ mm}^2$$

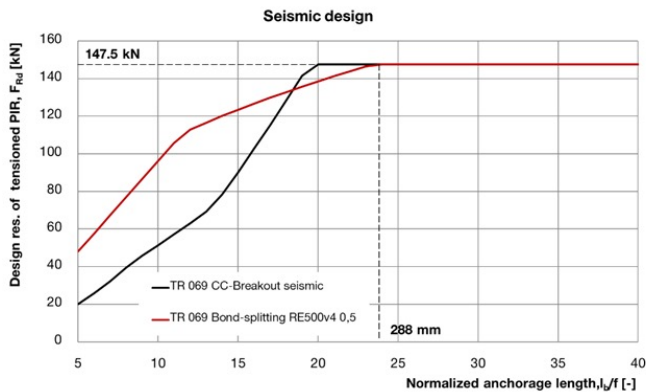

Fig. 6.21: Graphic representation of the required anchorage length for the seismic load case

$$\psi_{s,N} = 1.0 \quad \text{no influence of edges} \quad \text{EOTA TR 069, sect. 4.3 (3)}$$

$$\psi_{ec,N} = 1.0 \quad \text{no eccentricity} \quad \text{EOTA TR 069, sect. 4.3 (4)}$$

$$\psi_{re,N} = 1.0 \quad \text{no negative influence of surface reinforcement} \quad \text{EOTA TR 069, sect. 4.3 (5)}$$

$$\psi_{M,N} = 2 - z/(1.5 \cdot l_b) = 2 - 251/(1.5 \cdot 288) = 1.42 \quad \text{EOTA TR 069, eq. (4.9)}$$

$$N_{Rd,c,eq} = 0.85 \cdot 206.5 \cdot 943,488 / 746,496 \cdot 1.0 \cdot 1.0 \cdot 1.0 \cdot 1.42/1.5 = 210.0 \text{ kN} > 147.3 \text{ kN}$$

Verification fulfilled ✓

Bond-splitting verification:

$$\tau_{Rk,sp} = \eta_1 \cdot \alpha_{eq,sp} \cdot A_k \cdot \left(\frac{f_{ck}}{25}\right)^{sp1} \cdot \left(\frac{25}{\phi}\right)^{sp2} \cdot \left[\left(\frac{c_d}{\phi}\right)^{sp3} \cdot \left(\frac{c_{max}}{c_d}\right)^{sp4}\right] \cdot \left(\frac{7\phi}{l_b}\right)^{lb1} \quad \text{EOTA TR 069 eq. (4.11a) +}$$

ETA-20/0539

$$\tau_{Rk,sp} = 1.0 \cdot 0.95 \cdot 4.4 \cdot \left(\frac{30}{25}\right)^{0.29} \cdot \left(\frac{25}{12}\right)^{0.27} \cdot \left[\left(\frac{51}{12}\right)^{0.68}\right] \cdot \left(\frac{7 \cdot 12}{288}\right)^{0.60} = 6.9 \text{ N/mm}^2$$

$$\tau_{Rk,sp} \leq \tau_{Rk,ucr} \cdot \left(\frac{f_{ck}}{20}\right)^m \cdot \left(\frac{20 \cdot \phi}{l_b}\right) = 15 \cdot (30/20)^{0.1} \cdot (20 \cdot 12/288)^{0.6} = 14.0 \text{ N/mm}^2 \quad \text{splitting is decisive}$$

$$N_{Rd,sp} = \tau_{Rk,sp} \cdot l_b \cdot \phi \cdot \pi/1.5 = 6.9 \cdot 12 \cdot 288 \cdot \pi/1.5 = 49.9 \text{ kN} > 49.1 \text{ kN} \quad \text{Verification fulfilled ✓}$$

Post-installed reinforcement in the compression zone

For the sake of simplicity, in the case of seismic design, it is recommended to have symmetric reinforcement for both layers to account for a possible change of direction of the bending moment during the seismic event accounting for reversal of stresses.

## Summary

As expected, the seismic design case is decisive for anchorage of the post-installed reinforcement according to EOTA TR 069 [2]. To complete the design of the connection the following should be observed:

- The design according to EOTA TR 069 [2] covers only the anchorage length of the post-installed rebars
- The interface shear-transfer needs to be checked separately
- The local transfer of the tension forces in the existing wall is ensured by the condition  $l_b/h = 288/350 = 0.82 > 0.8$  EOTA TR 069, sect. 8 and EC2-4, Annex A
- The capacity of the existing wall to resist the actions introduced by the new beam needs to be checked separately.



## 7. DESIGN OF SHEAR-FRICTION (OVERLAY) APPLICATIONS

### 7.1 Interface shear transfer & shear-friction theories

As indicated in the previous chapters, the interface shear transfer needs to be verified for concrete cast at different times. Classical shear-friction theories of reinforced concrete (r.c.) members cast at different times, as per state-of-the-art standards such as EN 1992-1-1 (EC2-1-1) [1] cater predominantly to applications where the longitudinal shear stresses at the interface arise due to the new layer (such as in wall strengthening or slab overlays (see Fig. 7.1a). Load transfer of these predominant longitudinal shear stresses at the interface are by the following components of shear resistance: adhesion/interlock and friction action from rebars used as dowels. However, they need to be placed with sufficient length for yielding which might require a thick concrete section.

The interface shear transfer is also a relevant topic in application, where a bending moment might be the dominant action (see Fig. 7.1b). In this case, different design approaches might be more appropriate as discussed in this chapter.

More recently, EOTA published the TR 066 [4] “*Design & Requirements for construction works of post-installed shear connection for two concrete layers*” to provide solutions for thin overlays, as commonly required for strengthening of reinforced concrete elements using special shear connectors (see Fig. 7.1c).

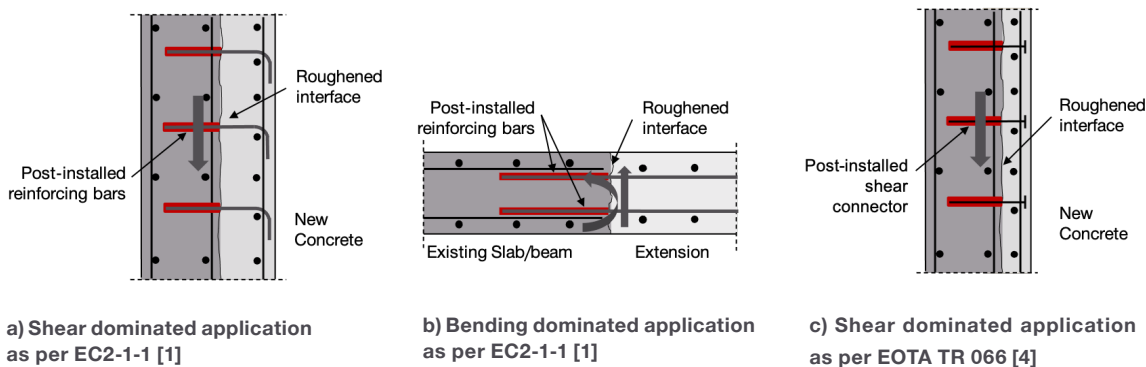

Fig. 7.1: Interface shear transfer in different applications

Different design methods are applicable depending on the loading type acting on the interface and they may involve the use of different types of shear connectors. An overview is given in Table 7.1. In the following sections guidance is provided on how to ensure the shear-transfer across interface types as shown in Fig. 7.1.

Table. 7.1. Overview of available design methods for different loading cases

Design method	Loading type	Connector type	Anchorage length
EC2-1-1	Static	Post-installed rebars with ETA as per EAD 330087	$l_{bd,y}$ acc. to EC2-1-1
	Fatigue	N.A.	
EOTA TR 066	Static	Shear-connectors with ETA as per EAD 332347	$40 \text{ mm} \leq h_{ef} \leq 20 \phi$ acc. to EC2-4
	Fatigue		
	Seismic		
Hilti Method	Static	Post-installed rebars designed as anchor	
	Seismic		

### 7.1.1 Design of shear interface according to EC2-1-1 provisions (for predominant shear)

In the simplest case of a shear force acting perpendicular to the interface, the parallel shear stress at

$$v_{Ed,i} = \beta \cdot \frac{V_{Ed,i}}{z \cdot b_i} \quad \text{EC 2-1-1 eq. (6.24)}$$

where,

$V_{Ed,i}$  is the external design shear force

$z$  is the inner lever arm of the composite cross section

$b_i$  is the width of the interface of the composite cross section

$\beta$  is the ratio of longitudinal force in the new concrete and the total longitudinal force either in the compression or tension zone, both calculated for the section considered. This ratio is usually taken as 1.0 to be conservative, however depending on the loading zones along the primary direction of the loaded member, the value of  $\beta$  shall be calculated as shown in Fig. 7.2.

**Note:** The calculation of the acting interface shear may significantly vary for different applications.

#### Positive bending moment, compressed part of the slab all contained in the overlay depth

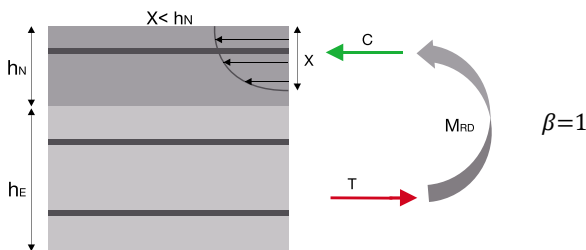

#### Positive bending moment, compressed part of the slab not fully contained in the overlay depth

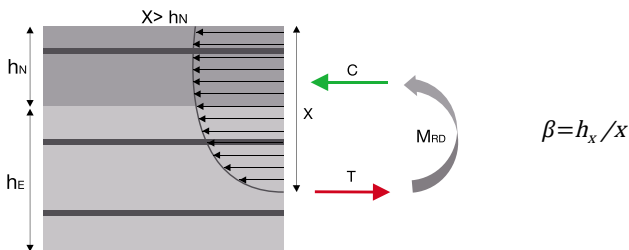

#### Negative bending moment

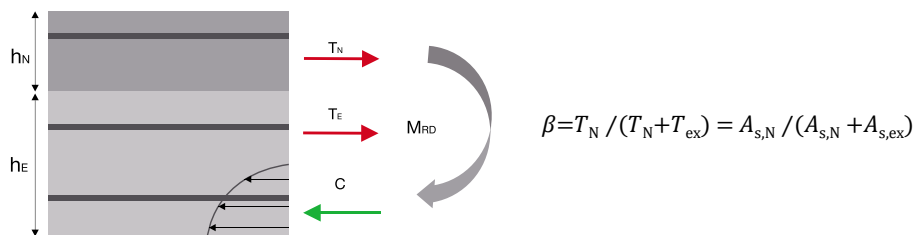

Fig. 7.2: Calculation of factor ' $\beta$ ' in the equation (6.25) of EC2-1-1 [1]

The interface design shear resistance ( $V_{Rdi}$ ) verification provision given in EC2-1-1 [1], section 6.2.5 is as follows:

$$V_{Rdi} = c \cdot f_{ctd} + \mu \cdot \sigma_n + \rho \cdot f_{yd}(\mu \sin \alpha + \cos \alpha) \leq 0.5 \cdot v \cdot f_{cd} \quad \text{EC2-1-1, eq. (6.25)}$$

where,

$c$  and  $\mu$  are factors depending on roughness of interface (see Table 7.2)

$f_{ctd}$  is the design tensile strength of concrete

$f_{cd}$  is the design compressive strength of concrete

$f_{yd}$  is the design yield strength of steel reinforcement

$\sigma_n$  is stress per unit area caused by the minimum external normal force across the interface that can act simultaneously with the shear force, such that  $\sigma_n < 0.6f_{cd}$  and negative for tension. When  $\sigma_n$  is tensile  $c \cdot f_{ctd}$  should be taken as 0

$\rho$  is the ratio of area of reinforcement across the interface including ordinary shear reinforcement, with adequate anchorage at both sides of the interface ( $A_s$ ) to area of the joint ( $A$ )

$\alpha$  shall be limited by 45° to 90° (refer sect. 6.2.5 of EC2-1-1 [1])

$v$  is the strength reduction factor for concrete cracked in shear depending on national regulations. The recommended value is  $v = 0.6(1 - \frac{f_{ck}}{250})$

Table. 7.2. Surface roughness factors

Surface characteristics of interface	$c$	$\mu$
Indented: a surface with indentations complying with Fig. 7.6	0.5	0.9
Rough: a surface with at least 3 mm roughness at about 40 mm spacing, achieved by raking, exposing of aggregate or other methods giving an equivalent behavior	0.45	0.7
Smooth: a slipformed or extruded surface, or a free surface left without further treatment after vibration	0.35	0.6
Very smooth: a surface cast against steel, plastic or specially prepared wooden molds	0.25	0.5

This equation is applicable in situations, where the adhesion is sufficient to resist the entire design shear load ( $c \cdot f_{ctd} + \mu \cdot \sigma_n \geq V_{Edi}$ ). In such cases there is no requirement for dowel bars at the interface, hence only minimum embedment length ( $l_{bd,min}$ ) is calculated in tension according to section 6.2 of this handbook.

If the adhesion resistance is not sufficient to resist the applied shear stress, then shear dowels are required to cross the interface with adequate anchorage length ( $l_{bd,y}$ ) for yielding on both sides of the interface (this dictates the need for thicker sections). The calculation of the required anchorage length for post-installed rebars follows the provisions explained in [chapter 5](#) and [chapter 6](#) for the design of lap splices and end anchorages.

**Note:**

- As stated in the EC2-1-1, section 6.2.5, the contribution of the concrete in the tension zone should be neglected (i.e.,  $\sigma_n < 0$ ).
- Rebars which are taking tension from bending cannot be accounted to resist tension arising from shear, because the eq. (6.25) of EC2-1-1 does not consider an interaction between shear and tension loading.
- The eq. (6.25) of EC2-1-1 also cannot be used if the entire cross-section is in tension.

### 7.1.2 Design of shear interface when loading is not predominant shear

The classical shear-friction theories are not always applicable where the loading conditions are different and include transfer of bending moment that causes tension and compression in addition to the interface shear, i.e., no predominant shear force (see Fig. 7.3.). This is the common case in bending resistant connections with or without small compression loading (e.g., beam / slab to column / wall connections). The German national annex to EC2-1-1 (DIN EN 1992-1-1 NA 2013-04 [38]) provides clear guidance for the verification of this load transfer, which is summarized in Table 7.3.

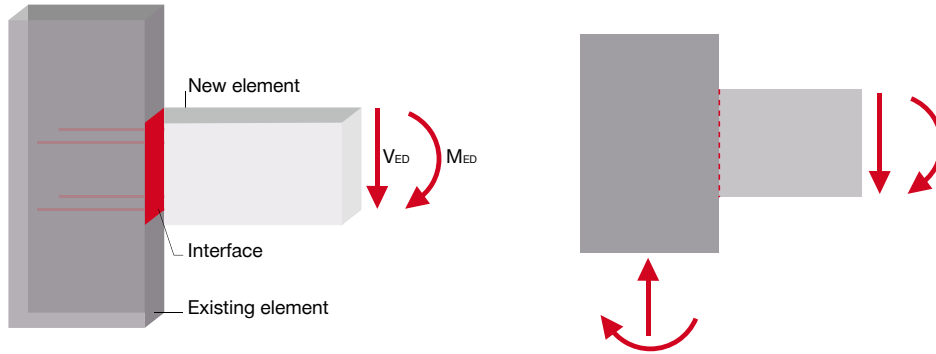

Fig. 7.3: Load transfer between existing and new concrete element (no predominant shear load)

Table 7.3. Hilti recommendation for design of interface shear verifications for cold joint

Loading type	Loading ratio	Verification
Predominant shear with or without compression	$e_d/h < 3.5$	Section 6.2.5 of EC2-1-1
Predominant bending	$e_d/h \geq 3.5$	Section 6.2.2 including requirements of DIN EN 1992-1-1 NA 2013-04 <b>(without shear reinforcement)</b>
Predominant bending	$e_d/h \geq 3.5$	Section 6.2.3 including requirements of DIN EN 1992-1-1 NA 2013-04 <b>(with shear reinforcement)</b>

Where,  $e_d = M/N$  is the eccentricity of the bending moment to the center of the cross-section  
 $h$  is the height of the concrete element

Modified shear verifications following the provisions of DIN EN 1992-1-1 NA 2013-04 [38] mentioned in Table 7.2 are shown below:

- Design shear resistance of the interface for elements without shear reinforcement,

$$V_{Rd,c} = \left[ C_{Rd,c} \cdot k \cdot (100 \cdot \rho_1 \cdot f_{ck})^{\frac{1}{3}} + k_1 \cdot \sigma_{cp} \right] \cdot b_w \cdot d \cdot c / 0.5 \geq (v_{min} + k_1 \cdot \sigma_{cp}) \cdot b_w \cdot d \cdot c / 0.5$$

DIN EN 1992-1-1 NA 2013-04, eq. (6.2a) & (6.2b)

- Design shear resistance of the interface for elements with shear reinforcement shall be minimum of the two equations below,

$$V_{Rd,max} = \alpha_{cw} \cdot b_w \cdot z \cdot v_1 \cdot f_{cd} \cdot (\cot \theta + \cot \alpha) / (1 + \cot^2 \theta) \cdot c / 0.5$$

DIN EN 1992-1-1 NA 2013-04, eq. (6.8)

$$V_{Rd,s} = \frac{A_{sw}}{s} \cdot z \cdot f_{ywd} \cdot \cot \theta$$

DIN EN 1992-1-1 NA 2013-04, eq. (6.9)

Note: These verifications are applicable only for rough or indented interfaces.

where,

$c$  is the surface roughness factor according to EC2-1-1 [1] ( $c = 0.4$  for rough surfaces and  $c = 0.5$  for indented surfaces)

## 7.2 Design of shear-friction applications (overlays) – static

### 7.2.1 Design of shear interface according to EC2-1-1 provisions

Design provisions mentioned in section 7.1.1 of this handbook may apply. However, these provisions have a significant drawback in that the anchorage length of the post-installed rebars used as shear connectors is very long on both sides of the interface (usually  $l_{bd,y} \approx 30$  to 40 diameters). This design requirement makes many strengthening applications unfeasible, since typical overlay thickness might range between 50 mm and 200 mm.

### 7.2.2 Design of shear-friction applications (overlays) as per EOTA TR 066

As mentioned in [chapter 3](#), EOTA TR 066 [4] gives design provisions at an ultimate limit state for new concrete overlays/strengthening over an existing concrete member through shear transfer without significant transverse bending. EOTA TR 066 [4] includes two possible design approaches:

**Note:** The EOTA TR 066 provides solutions for thin overlays.

**Unreinforced interface:** monolithic behavior, i.e., **strong adhesive bond** is assumed and no shear connectors are required; and

**Reinforced interface:** composite behavior, i.e., **weak adhesive bond** is assumed where shear connectors are used across the shear interface to transmit the tensile forces generated by friction, and then into the concrete layers.

**Note:** An unreinforced interface should be assumed only if the interface is expected to stay uncracked over the entire service life of the member. Cracking of an unreinforced interface may cause a brittle failure of the structural element.

For both approaches the most important design parameter is the **interface roughness**. EOTA TR 066 [4] recognized 4 different roughness levels (refer Table 7.4). The scientific background of this design method is discussed in [39] and [40].

Table. 7.4. Categories of surface roughness according to EOTA TR 066

Category	Methods/ situation (examples)	Application			Peak to mean roughness $R_t$ (mm)
		Static and quasi-static	Fatigue loading	Seismic loading	
Very rough	Shear key	Yes	Yes	-	See EOTA TR 066
	High pressure water jetting, sandblasting, indented	Yes	Yes	Yes (both categories to be handled as 'rough')	$\geq 3.0$
Rough	Sandblasted	Yes	Not applicable		$\geq 1.5$
Smooth	Untreated, slightly roughened (e.g., as cast after removal of laitance and loose material)	Yes	Not applicable	Yes	$< 1.5$
Very smooth	Existing concrete cast against steel formwork	Yes	Not applicable	Not applicable	Not measurable

According to EOTA TR 066 [4], there are two types of load actions/forces acting on the system:

#### External Forces:

See section 7.1.1.

#### Forces resulting from restraint at the perimeter due to concrete shrinkage:

The resulting shear stress from restraint ( $\tau_{Ed}^*$ ) along the perimeter (see Fig. 7.4) is given by

The cracking force in the new layer due to restraint at the perimeter

$$V_{Ed,j}^* = h_{new} \cdot b_j \cdot f_{ctd} \quad \text{EOTA TR 066, eq. (2.2)}$$

$$\tau_{Ed}^* = \frac{V_{Ed,j}^*}{l_e \cdot b_j} = h_{new} \cdot \frac{f_{ctd}}{l_e} \quad \text{EOTA TR 066, eq. (2.2)}$$

where,

$h_{new}$  is the thickness of the new concrete layer (also referred as  $h_{ov}$  in this handbook)

$b_j$  is the depth of the respective area of the composite section considered

$f_{ctd}$  is the design tensile strength of new layer of concrete

$l_e$  is the width of the restraint area of the interface at the perimeter which is given by

- $l_e = 3 \cdot h_{new}$  for very rough surfaces
- $l_e = 6 \cdot h_{new}$  for rough surfaces
- $l_e = 9 \cdot h_{new}$  for smooth and very smooth surfaces



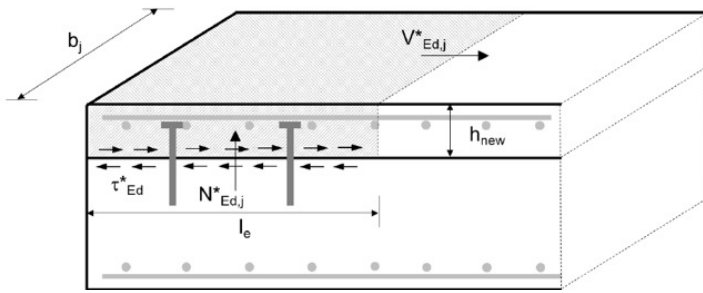

**Note:** The width of the perimetral zones is a function of the interface roughness.

Fig. 7.4: Schematic representation of connectors to resist restraint forces along the perimeters (ref. EOTA TR 066 [4])

The restraint forces at the perimeter may be neglected, if other measures are taken or if the boundary conditions are such that no tension at the perimeter occurs (e.g., self-weight of a wall on its bottom side). These forces activate uplift forces perpendicular to the interface,  $N_{ed,j}^*$ , which are carried by the shear connectors and transferred into the two concrete layers.

$$N_{ed,j}^* = \frac{V_{Ed,j}^*}{6} = \frac{h_{new} \cdot b_j \cdot f_{ctd}}{6} \quad \text{EOTA TR 066, eq. (2.4)}$$

EOTA TR 066 [4] allows for subdivision of the interface into zones to contribute to different shear stresses resulting from uniformly distributed design forces  $V_{Ed}$  (see Fig. 7.5)

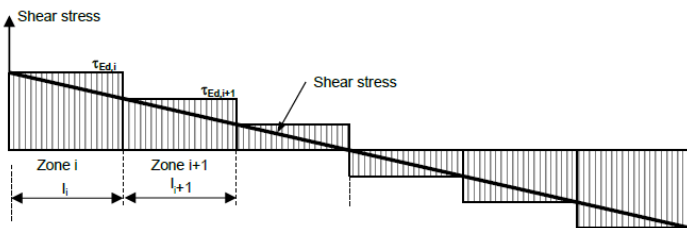

a) Discretization of resisting interface shear with step function

**Note:** If the interface is "smooth" or "very smooth", average stress instead of the maximum stress in each zone may be considered.

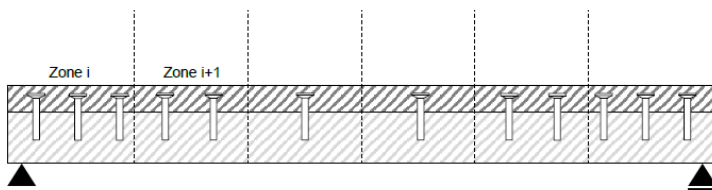

b) Resulting required connectors in different zones

Fig. 7.5: Stepped distribution of shear stress (ref. EOTA TR 066 [4])

**Required verifications**

Verification against external forces is given by:

$$\tau_{Ed} = \tau_{Ed,i} \leq \tau_{Rd,i} \quad \text{EOTA TR 066, eq. (2.5)}$$

**Note:** The external forces and forces from perimeter restraint are not superimposed.

Verification against forces from restraint at the perimeter is given by:

$$\tau_{Ed} = \max(\tau_{Ed,i}; \tau_{Ed}^*) \leq \tau_{Rd} \quad \text{EOTA TR 066, eq. (2.6)}$$

$$N_{Ed} = N_{Ed,j}^* \leq N_{Rd} \quad \text{EOTA TR 066, eq. (2.7)}$$

## Design resistances

The design shear resistance ( $\tau_{Rd}$ ) for interfaces without shear connectors (strong adhesive bond) is given by the equation:

$$\tau_{Rd} = c_a \cdot f_{ctd} + \mu \cdot \sigma_n \leq 0,5 \cdot v \cdot f_{cd} \quad \text{EOTA TR 066, eq. (2.9)}$$

where,

$c_a$  and  $\mu$  are factors dependent on different surface roughness given in Table 7.5

$$v = 0,55 \left( \frac{30}{f_{ck}} \right)^{\frac{1}{3}} \leq 0,55 \quad \text{EOTA TR 066, eq. (2.10)}$$

$\sigma_n \geq 0$  (no tension is allowed)

$f_{ctd}, \sigma_n, f_{cd}$  : see section 7.1.1.

**Note:** An unreinforced interface may be assumed for static/fatigue loads, but not for seismic actions.

Table 7.5. Coefficients and parameters for different surface roughness (ref. EOTA TR 066)

Surface characteristics of interface	$C_a$	$C_r$	$\kappa_1$	$\kappa_2$	$\beta_c$	$\mu$	
						$f_{ck} \geq 20$ MPa	$f_{ck} \geq 35$ MPa
<b>Very rough</b> (including shear keys!) $R_t \geq 3.0$ mm	0.5	0.2	0.5	0.9	0.5	0.8	1.0
<b>Rough</b> $R_t \geq 1.5$ mm	0.4	0.1	0.5	0.9	0.5	0.7	
<b>Smooth</b> (concrete surface without treatment after vibration or slightly roughened when cast against formwork)	0.2	0	0.5	1.1	0.4	0.6	
<b>Very smooth</b> (steel, plastic, timber formwork)	0.025	0	0	1.5	0.3	0.5	

1) Shear keys should satisfy the geometrical requirements given in Fig. 7.6

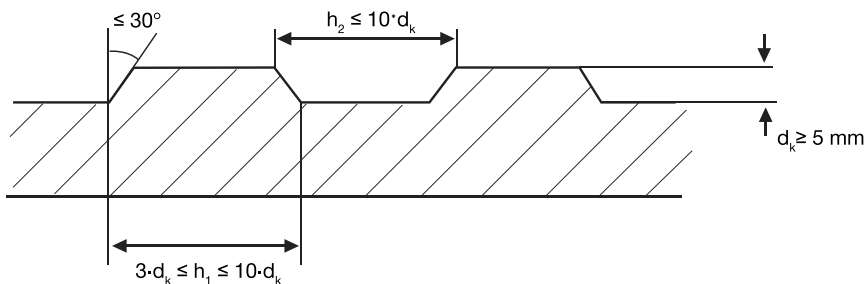

Fig. 7.6: Geometry of shear keys (ref. EOTA TR 066 [4])

The design shear resistance ( $\tau_{Rd}$ ) for interfaces with shear connectors (weak adhesive bond) is given by eq. (2.11) of EOTA TR 066:

$$\tau_{Rd} = c_r \cdot f_{ck}^{1/3} + \mu \cdot (\sigma_n + \kappa_1 \cdot \alpha_{\kappa 1} \cdot \rho \cdot \sigma_s) + \kappa_2 \cdot \alpha_{\kappa 2} \cdot \rho \cdot \sqrt{\frac{f_{y,k}}{\gamma_s} \cdot \frac{0,85 \cdot f_{ck}}{\gamma_c}} \leq \beta_c \cdot v \cdot \frac{0,85 \cdot f_{ck}}{\gamma_c}$$

This equation comprises of the three different working principles discussed in section 2.2.2.

$c_r \cdot f_{ck}^{1/3}$  is the aggregate interlock component only applicable if no tension due to external loading  $\sigma_n$  is present

$\mu \cdot (\sigma_n + \kappa_1 \cdot \alpha_{\kappa 1} \cdot \rho \cdot \sigma_s)$  is the shear friction component

$$\kappa_2 \cdot \alpha_{k2} \cdot \rho \cdot \sqrt{\frac{f_{yk}}{\gamma_s} \cdot \frac{0,85 \cdot f_{ck}}{\gamma_c}}$$

is the dowel action component

$$\beta_c \cdot \nu \cdot \frac{0,85 \cdot f_{ck}}{\gamma_c}$$

is the limiting concrete strut resistance

where,

- $c_r, \mu, \kappa_1, \kappa_2$  and  $\beta_c$  are factors dependent on surface roughness given in Table 7.5
- $\alpha_{k1}$  product-specific factor for ductility of the shear connector (see relevant ETA)
- $\sigma_s = \min(N_{Rd,s}; N_{Rd,c}; N_{Rd,p}; \dots) / A_s \leq f_{yk} / \gamma_s$  (steel stress as per relevant failure modes of EC2-4 [3])
- $f_{yk}$  = product-specific factor for shear connector (see relevant ETA)
- $\gamma_s = 1.15$  and  $\gamma_c = 1.5$  as per EC2-1-1 [1]
- $\alpha_{k2}$  = factor for bending capacity of the shear connector (see relevant ETA)
- $f_{ck}, \sigma_n, \rho$  see section 7.1.1

For the calculation of  $\sigma_s$  all possible failure modes in the new and existing concrete layers should be calculated according to the provisions of EC2-4 [3] (refer Fig. 7.7). The smallest resistance is decisive. These hand calculations may be quite laborious. However, they can be done very quickly with PROFIS Engineering. See [chapter 8](#) for more details.

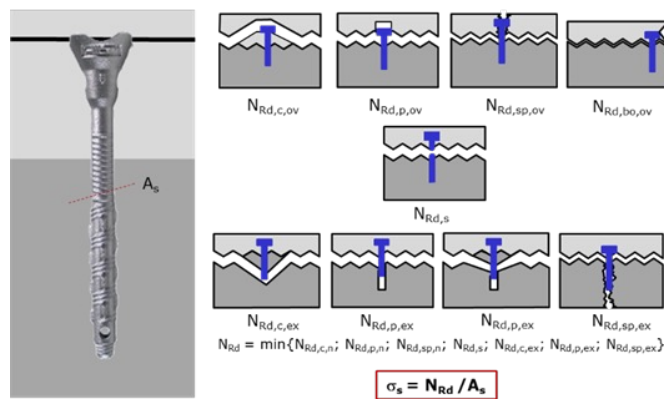

Fig. 7.7: Anchor verifications to be carried out to determine  $\sigma_s$

### 7.2.3 Additional detailing rules for shear connectors as per EOTA TR 066

The following additional detailing rules shall also be satisfied:

- **The minimum spacing of the shear connectors** ( $s_{min}$ ) shall be the maximum of the spacing required in existing as well as overlay concrete,
 
$$s_{min} = \max(s_{min}(\text{existing concrete}); s_{min}(\text{overlay concrete}))$$
- **The minimum reinforcement ratio** ( $\rho_{min}$ ) to prevent brittle failure due to loss of aggregate interlock (when weak adhesion bond conditions are assumed) allowing for redistribution of stresses and to ensure composite behaviour of the new combined section, is given by the equations:

Note: When an unreinforced interface is assumed, a minimum reinforcement is not required.

$$\rho_{min} = 0,20 \cdot \frac{f_{ctm}}{f_{yk}} \geq 0,001 \quad (\text{for general linear elements like beams, columns}) \quad \text{TR 066, eq. (2.21a)}$$

$$\rho_{min} = 0,12 \cdot \frac{f_{ctm}}{f_{yk}} \geq 0,005 \quad (\text{for 2D elements like slabs, walls}) \quad \text{EOTA TR 066, eq. (2.21b)}$$

$$\rho_{min} = \frac{A_{s,min}}{A_c} \quad \text{EOTA TR 066, eq. (2.22)}$$

where,

- $f_{ctm}$  is mean tensile strength of concrete
- $f_{yk}$  is product specific characteristic yield strength of shear connector (see relevant ETA)
- $A_{s,min}$  is the relevant cross-sectional area of minimum shear connectors at the interface
- $A_c$  is the sectional area of concrete relevant to  $A_{s,min}$

- The minimum edge ( $c_{min}$ ) & spacing distance ( $s_{min}$ ) of shear connectors is given by Fig. 7.8 below where 'd' indicated the diameter of the shear connector.

The minimum concrete edge and axial spacing distances are to prevent premature splitting failure in parallel and perpendicular directions of the shear connectors and also to improve bonding conditions of the reinforcement crossing between the interface of the two concrete layers (existing and new). EOTA TR 066 [4] assumes no contribution from edge reinforcement in the existing concrete layer to be on the safer side.

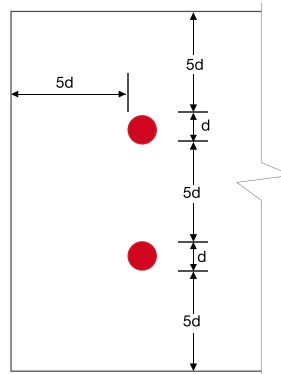

Fig. 7.8: Minimum edge and spacing requirements for shear connectors

- In the case of unreinforced interface, **constructive reinforcement** should be provided to support the new concrete layer as per the relevant local codes of construction. A minimum of 2 connectors per m<sup>2</sup> with a distance not larger than 700 mm is recommended [41].

### 7.3 Design of concrete shear-friction applications (overlays) – Fatigue

#### 7.3.1 Design as per EC2-1-1

The provisions of EC2-1-1 [1] explained in section 7.1.1 are applicable also for fatigue loading. For this loading case the value of roughness coefficient  $c$  should be halved (see EC2-1-1 [1], section 6.2.5). For bridges the factor  $c$  should be taken as zero (see EC2-3 [42], section 6.2.5). While these applications can be designed using post-installed rebar systems, no European assessment of post-installed rebars for fatigue loading is currently available. Refer to [43] for the scientific background.

Note: Hilti post-installed rebar systems hold a German national approval that cover fatigue loading.

#### 7.3.2 Design as per EOTA TR 066

The design provisions of the shear interface of two concrete layers cast at different times for fatigue loads are only applicable when fulfilling the following requirements:

- The interface surface is limited to be very rough for fatigue loading design of the interface.
- Only shear connectors with an ETA according to EAD 332347 [23] covering fatigue case may be used.
- Concrete strength classes of both existing and new concrete layers as per relevant ETA.
- The following verification condition shall be satisfied for the shear design resistance for fatigue loads:

Note: According to EOTA TR 066, no fatigue design of connectors is required.

$$\Delta\tau_{Ed} \leq \eta_{sc} \cdot \tau_{Rd} \quad \text{EOTA TR 066, eq. (2.13)}$$

where,

$\eta_{sc}$  is the factor for fatigue loading of shear connectors depending upon on superimposition of cyclic (Fatigue) stress and its direction on the static action. This value is to be taken from relevant ETA(s)

$\tau_{Rd}$  is the design shear resistance for static loading case as per EOTA TR 066 [4] (refer sect. 7.2.1)

The limits of cyclic (Fatigue) stresses and design resistance ratios are shown in Fig. 7.9, in which  $\eta_{sc} = 0.4$  is taken as a cornerstone for the Goodman Diagram.

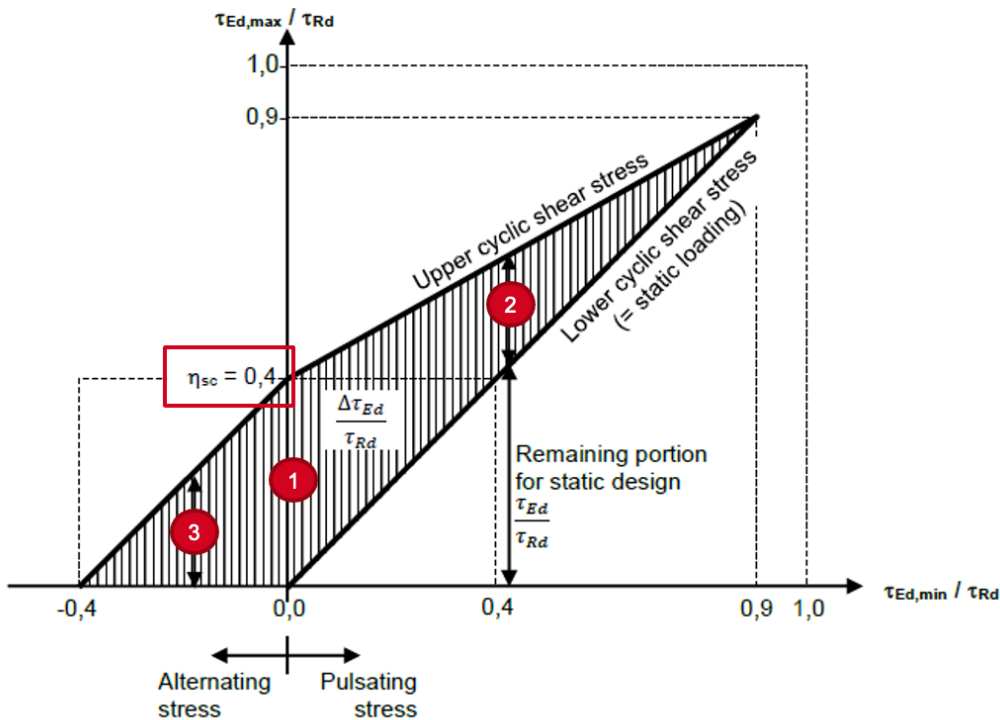

Fig. 7.9: Constant life diagram (Goodman diagram, ref. EOTA TR 066 [4])

For the above stated verification, following three different situations may occur:

1. No occurrence of static loading, **only cyclic (Fatigue) action**, i.e.,  $\tau_{Ed,min} = 0$  :

$$\Delta\tau_{Ed} = \tau_{Ed,max} \quad \text{EOTA TR 066, eq. (2.14)}$$

$$\frac{\tau_{Ed,max}}{\tau_{Rd}} \leq \eta_{sc} \quad \text{EOTA TR 066, eq. (2.15)}$$

2. **Fatigue and static action with the same sign** (same direction) with  $\tau_{Ed,min} > 0$  :

For cyclic (Fatigue) shear stress as given in Fig. 7.9

$$\Delta\tau_{Ed} = \tau_{Ed,max} - \tau_{Ed,min} \quad \text{EOTA TR 066, eq. (2.16)}$$

For upper cyclic (Fatigue) shear stress as given in Fig. 7.9:

$$\frac{\tau_{Ed,max}}{\tau_{Rd}} \leq \eta_{sc} + 0.55 \frac{\tau_{Ed,min}}{\tau_{Rd}} \leq 0.9 \quad \text{EOTA TR 066, eq. (2.17a)}$$

For lower cyclic (Fatigue) shear stress = Maximum static shear stress as given in Fig. 7.9:

$$0 < \frac{\tau_{Ed,min}}{\tau_{Rd}} = \frac{\tau_{Ed}}{\tau_{Rd}} \quad \text{EOTA TR 066, eq. (2.17b)}$$

3. **Fatigue and static action with different sign** (different directions) with  $\tau_{Ed,min} < 0$  :

For cyclic (Fatigue) shear stress as given in Fig. 7.9:

$$\Delta\tau_{Ed} = \tau_{Ed,max} - |\tau_{Ed,min}| \quad \text{EOTA TR 066, eq. (2.18)}$$

For upper cyclic (Fatigue) shear stress as given in Fig. 7.9:

$$\frac{\tau_{Ed,max}}{\tau_{Rd}} \leq \eta_{sc} - \frac{|\tau_{Ed,min}|}{\tau_{Rd}} \quad \text{EOTA TR 066, eq. (2.19)}$$

## 7.4 Design of concrete shear-friction applications (overlays) – Seismic

### 7.4.1 Design as per EOTA TR 066

The derivation of the seismic forces and their transfer mechanism is similar to the provisions given in section 7.2.1. The seismic forces required to be transferred through an interface depend on the repair/strengthening application.

**Note:** Eurocode does not have provisions for design of overlays for seismic loads.

#### Required verifications for seismic loads

Verification of resistances as per different failure modes shall be calculated assuming seismic performance category C1 or C2 according to EC2-4 [3] depending on the design assumption and application. The various decisive failure modes include:

- Steel yielding of connectors (to ensure ductile behavior of structural members)
- Concrete-related failure modes under tension loading for existing and overlay concrete (cone failure, splitting failure, pull-out failure and blowout failures)
- Different requirements such as capacity design failure checks depending on design assumptions such as checks for prevention of existing concrete layer collapse in failure of overlay, anchorage checks for connectors in the existing concrete, etc.

**Note:** The seismic forces are usually not superimposed with static forces as well as forces from perimeter restraint.

#### Design resistances

The design shear resistance ( $\tau_{Rd,seis}$ ) at the interface between concrete cast at different times shall satisfy the following,

$$\tau_{Ed,seis} \leq \tau_{Rd,seis} \quad \text{EOTA TR 066, eq. (3.1)}$$

where,  $\tau_{Rd,seis}$  is the seismic load action

$$\tau_{Rd,seis} = \alpha_{seis} [c_r \cdot f_{ck}^{1/3} + \mu \cdot (\sigma_n + \kappa_1 \cdot \alpha_{\kappa 1} \cdot \rho \cdot \sigma_{s,eq}) + \kappa_2 \cdot \alpha_{\kappa 2} \cdot \rho \cdot \sqrt{f_{yd} \cdot f_{cd}}] \leq \beta_c \cdot v \cdot f_{cd}$$

$$\text{EOTA TR 066, eq. (3.2)}$$

**Note:** The upper limit for  $\tau_{Rd,seis}$  shall be equal to  $\tau_{Rd}$

where,  $f_{cd} = \frac{f_{ck}}{\gamma_c}$

The design coefficients of the above equation are described in section 7.2.2 and they require the following modifications:

$c_r$ ,  $\mu$ ,  $\kappa_1$ ,  $\kappa_2$  and  $\beta_c$  are factors dependent on surface roughness given in Table 7.6 below

$\sigma_{s,eq} = \min(N_{Rd,s,eq}; N_{Rd,c,eq}; N_{Rd,p,eq}; \dots) / A_s \leq f_{yk} / \gamma_s$  (steel stress as per relevant failure mode under seismic conditions)

$\alpha_{seis}$  is product dependent seismic factor to be taken from relevant ETA (value  $\leq 1.0$ ).

Table 7.6. Factors related to surface roughness under seismic loading from EOTA TR 066 [4]

Surface characteristics of interface	$C_r$	$\kappa_1$	$\kappa_2$	$\beta_c$	$\mu$	
					$f_{ck} \geq 20 \text{ MPa}$	$f_{ck} \geq 50 \text{ MPa}$
<b>Rough</b> $R_i \geq 1.5 \text{ mm}$	0	0.5	0.9	0.5	$\mu = 0.4 \sqrt[3]{\left(\frac{f_{cd}}{\sigma_c + \sigma_n}\right)^2}$	$\mu = 0.27 \sqrt[3]{\left(\frac{f_{cd}}{\sigma_c + \sigma_n}\right)^2}$
<b>Smooth</b> $R_i < 1.5 \text{ mm}$	0	0.5	1.1	0.4	$\mu = 0.27 \sqrt[3]{\left(\frac{f_{cd}}{\sigma_c + \sigma_n}\right)^2}$	$\mu = 0.135 \sqrt[3]{\left(\frac{f_{cd}}{\sigma_c + \sigma_n}\right)^2}$

## 7.5 Design of shear-friction applications (overlays) as per Hilti Method

A traditional solution used for shear connectors in concrete overlays is the use of post-installed rebars with the bent end on the cast-in side. Following the principles of EOTA TR 066 [4] the Hilti Method allows a safer and more reliable design of interfaces using post-installed rebars with anchorage lengths significantly smaller than as per EC2-1-1 [1]. Due to the lack of radial symmetry of the head of rebars, the minimum anchorage lengths are longer than according to EOTA TR 066 [4].

This design method is based on the research work by Palieraki et al. [44], [45] that has demonstrated that the static and cyclic strength of the shear friction interface can be accurately described as the sum of friction and dowel action mechanisms (see Fig. 7.10).

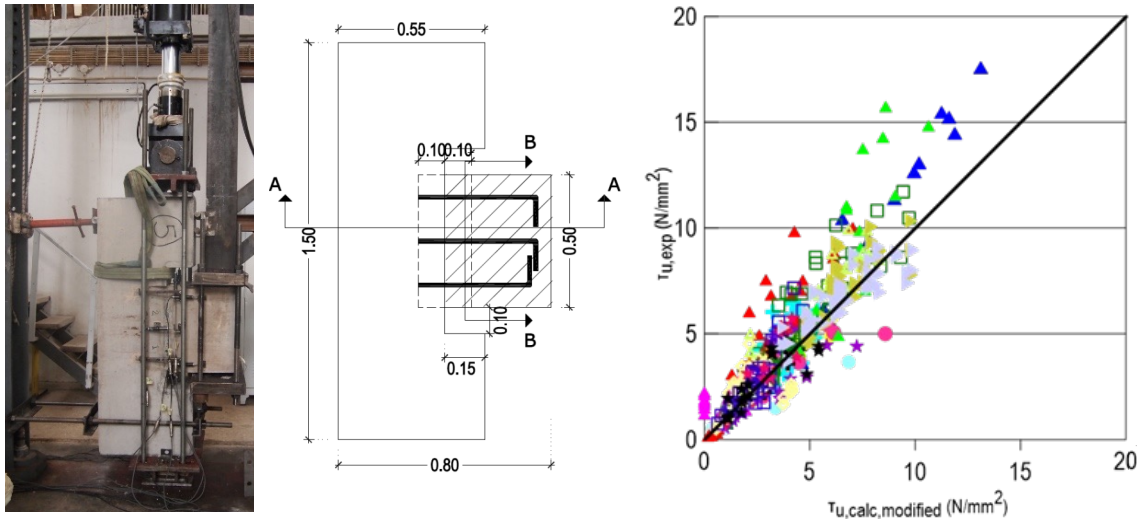

a) Typical test specimen and setup used to derive the shear-friction model (dimensions are in m)

b) Prediction of static and cyclic interface shear plotted against test results

Fig. 7.10: Derivation of shear-friction Hilti design method [45].

### 7.5.1 Design as per Hilti Method - Static

This design method is for calculating design shear resistance at the interface. It is based on modification of eq. (2.11) of EOTA TR 066 [4] for static and quasi-static loads and is applicable when following conditions are satisfied:

- Central and perimetral zones are defined as per design provisions in accordance to EOTA TR 066 [4]
- Only reinforced interfaces are allowed
- $h_{ef} = \min(h_{ef,ex}(\text{existing concrete}); h_{ef,ov}(\text{overlay concrete}))$
- The minimum  $h_{ef}$  shall be  $6d$  ( $d$  is diameter of shear connectors)
- Bent rebars in the overlay concrete shall conform to Fig. 8.1b of EC2-1-1 [1] (as shown in Fig. 7.11)
- All remaining parameters in the modified equation are same as according to EOTA TR 066 [4]

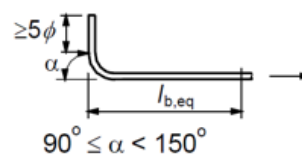

Fig. 7.11: Definition of standard bend according to EC2-1-1 [1]

The design shear resistance at the interface (using shear connectors) as per Hilti Method is a given below as:

$$\tau_{Rd} = \mu_h \cdot (\sigma_n + \kappa_{1h} \cdot \rho \cdot \sigma_s) + \kappa_{2h} \cdot \rho \cdot \sqrt{\frac{f_{yk}}{\gamma_s} \cdot \frac{\alpha_{cc} f_{ck}}{\gamma_c}} \leq \beta_c \cdot v \cdot \frac{\alpha_{cc} f_{ck}}{\gamma_c} \quad \text{EOTA TR 066, eq. (2.11)-modified}$$



where,

coefficient of friction  $\mu_h = 0.3 \sqrt[3]{\left(\frac{f_{cd}}{\sigma_c + \sigma_n}\right)^2}$  and  $\sigma_c = \rho \sigma_s$

$k_{1h}$  = depending on the surface roughness, loading and  $h_{ef}$  given in Table 7.7

$k_{2h}$  = depending on  $h_{ef}$  given in Table 7.8

Table. 7.7. Values for surface roughness factor  $k_{1h}$  (Hilti Method) for static loading

Interface characteristics	Monotonic loading
	$6d < h_{ef} < 20d$
Mechanically roughened ( $\geq 1.5$ mm)	0.6
Smooth surface ( $< 1.5$ mm)	0.4

Table. 7.8. Values for Factor  $k_{2h}$  (Hilti Method)

Normalized embedment Depth	Values
$h_{ef}/d > 8$	0.7
$6 \leq h_{ef}/d \leq 8$	$0.1 h_{ef}/d - 0.1$
$h_{ef}/d = 8$	0.5

### 7.5.2 Design as per Hilti Method - Seismic

Provisions of section 7.5.1. shall apply here as well for the seismic case, however with following modifications:

- The minimum  $h_{ef}$  shall be  $10d$  where  $d$  is diameter of shear connectors
- Values for surface roughness factor  $k_{1h}$  (Hilti Method) for seismic loading is given in Table 7.9.

Table. 7.9. Values for surface roughness factor  $k_{1h}$  (Hilti Method) for seismic loading

Interface characteristics	Seismic loading
	$10d < h_{ef} < 20d$
Mechanically roughened ( $\geq 1.5$ mm)	$0.02 h_{ef}/d + 0.2$
Smooth surface ( $< 1.5$ mm)	0.2

When post-installed rebars are used as shear connectors the bent in the overlay (Fig. 7.12a) should be oriented in the direction of the acting shear stress. This is not always feasible. Therefore, a longer embedment in the overlay than fasteners used as shear connectors. For fasteners the radial symmetry of the head embedded in the overlay allow a stable shear-force transfer in all directions (Fig. 7.12b).



Fig. 7.12: Comparison between (a) post-installed rebars and (b) concrete screws used as shear connectors

## 7.6 Design examples

### 7.6.1 Interface shear transfer in moment-dominated connection

Project requirement: the shear transfer in the beam-to-wall application studied in Sect. 7.1.2 is checked here in this example.

#### General design information

Geometry:	Wall thickness, $h = 350$ mm Beam section, $300 \times 300$ mm <sup>2</sup>
Materials:	Normal weight concrete C30/37 Reinforcing steel $f_{yk} = 500$ N/mm <sup>2</sup>
Loading:	$V_{Sd} = 50$ kN $M_{Sd} = 30$ kNm
Post-installed reinf.	3+3 $\phi 12$
Interface roughness:	rough ( $c=0.4$ )

Transverse reinforcement not taken into account  
Design working life: 50 years  
Cross-section analysis: See example in section 6.6.1

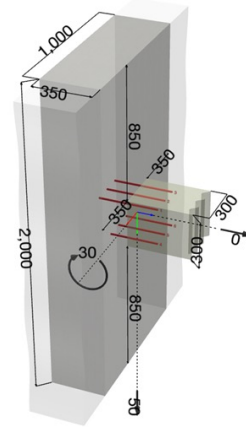

Fig. 7.13: Beam-to-wall moment connection

$$V_{Ed} \leq V_{Rd}$$

$$V_{Ed} \leq V_{Ed,limit}$$

$$V_{Ed,limit} = 0.5 \cdot b_w \cdot d \cdot v \cdot f_{cd} \quad \text{EC2-1-1, eq. (6.5)}$$

$$v = 0.6 \cdot (1 - f_{ck}/250) = 0.6 \cdot (1 - 30/250) = 0.53 \quad \text{EC21-1, eq. (6.6N)}$$

$$f_{cd} = \alpha_{cc} \cdot f_{ck} / \gamma_c = 0.85 \cdot 30 / 1.5 = 17.0 \text{ N/mm}^2 \quad \text{EC2-1-1, eq. (3.15)}$$

$$V_{Ed,limit} = 0.5 \cdot 300 \cdot 264 \cdot 0.53 \cdot 17 = 356.8 \text{ kN} > V_{Ed} = 50 \text{ kN}$$

$$V_{Rd} = \max\{V_{Rd,c}; V_{Rd,c,min}\} \cdot c / 0.5 \quad \text{EC2-1-1, eq. (6.2.2) + DE NA 2013-04}$$

$$V_{Rd,c} = \left[ C_{Rd,c} \cdot k \cdot (100 \cdot \rho_l \cdot f_{ck})^{\frac{1}{3}} + k_1 \cdot \sigma_{cp} \right] \cdot b_w \cdot d \quad \text{EC2-1-1, eq. (6.2.a)}$$

$$V_{Rd,c,min} = (v_{min} + k_1 \cdot \sigma_{cp}) \cdot b_w \cdot d \quad \text{EC2-1-1, eq. (6.2.b)}$$

$$C_{Rd,c} = 0.18 / \gamma_c = 0.18 / 1.5 = 0.12 \quad \text{EC21-1, Sect. 6.2.2 (1)}$$

$$k = 1 + \sqrt{200/d} \leq 2.0 \rightarrow 2.0 \quad \text{EC21-1, Sect. 6.2.2 (1)}$$

$$\rho_l = A_{sl} / (b_w \cdot d) = 0.004 \leq 0.02 \quad \text{EC21-1, Sect. 6.2.2 (1)}$$

$$\beta_{util} = F_{Ed,total} / (A_{sl} \cdot f_{yd}) \quad \text{Utilization of tension reinforcement}$$

$$\rho_{l,eff} = \rho_l \cdot \beta_{util} \quad \text{Effective ratio of tensile reinforcement}$$

$$k_1 = 0.15 \quad \text{EC21-1, Sect. 6.2.2 (1)}$$

$$\sigma_{cp} = N_{Ed} / A_c < 0.2 \cdot f_{cd} \quad \text{EC21-1, Sect. 6.2.2 (1)}$$

$$v_{min} = 0.035 \cdot k^{1.5} \cdot f_{ck}^{0.5} = 0.035 \cdot 2^{1.5} \cdot 25^{0.5} = 0.49 \quad \text{EC2-1-1, Sect. (6.3N)}$$

$$V_{Rd,c} = \left[ 0.12 \cdot 2 \cdot (100 \cdot 0.004 \cdot 30)^{\frac{1}{3}} + 0.15 \cdot 0 \right] \cdot 300 \cdot 264 = 43.2 \text{ kN}$$

$$V_{Rd,c,min} = (0.49 + 0.15 \cdot 0) \cdot 300 \cdot 264 = 38.8 \text{ kN}$$

$$V_{Rd} = \max\{43.2; 38.8\} \cdot 0.8 = 34.6 \text{ kN} \quad \text{EC2-1-1, eq. (6.2.2) + DE NA 2013-04}$$

$$V_{Ed} = 50 \text{ kN} > 34.6 \text{ kN} \quad \text{Verification not fulfilled} \quad \text{!}$$

The shear reinforcement in the new member needs to be taken into account to ensure the shear transfer through the interface.

$$V_{Rd} = \min\{V_{Rd,s}; V_{Rd,max}\} \cdot c / 0.5 \quad \text{EC2-1-1, Sect. 6.2.3 (3) + DE NA 2013-04}$$

$$V_{Rd,s} = A_{sw}/s \cdot z \cdot f_{ywd} \cdot \cot\theta$$

EC2-1-1, eq. (6.8)

 Assumption of closed stirrups  $\emptyset 10 / 100$  mm in proximity of the connection

$$V_{Rd,s} = 78.5/100 \cdot 238 \cdot 435 \cdot 1.091 = 88.7 \text{ kN}$$

$$V_{Rd,max} = \alpha_{cw} \cdot b_w \cdot z \cdot v \cdot f_{cd} \cdot (\cot\theta + \cot\alpha)/(1 + \cot^2\theta)$$

EC2-1-1, eq. (6.14)

$$V_{Rd,max} = 1 \cdot 300 \cdot 238 \cdot 0.53 \cdot 17 \cdot 1.091/2.191 = 320.3 \text{ kN}$$

$$V_{Rd} = \min\{88.7; 320.3\} \cdot 0.8 = 71.0 \text{ kN} > V_{Ed} = 50 \text{ kN}$$

Verification fulfilled ✓

## 7.6.2 Interface shear transfer in compression/shear dominated connection

Project requirement: The shear transfer in the column to foundation application is checked.

General design information:

Geometry: Foundation thickness,  $h = 800$  mm  
Column section,  $450 \times 450$  mm<sup>2</sup>

Materials: Normal weight concrete C25/30  
Reinforcing steel  $f_{yk} = 500$  N/mm<sup>2</sup>

Loading:  $N_{Ed} = 250$  kN  
 $V_{Ed,x} = 45$  kN;  $V_{Ed,y} = 75$  kN  
 $M_{Ed,x} = 150$  kNm;  $M_{Ed,y} = 90$  kNm

Post-installed reinf. 12  $\emptyset 20$

Interface roughness: rough ( $c=0.4$ ;  $\mu=0.7$ )

Transverse reinforcement not taken into account

Design working life: 50 years

Cross-section analysis

Inner lever arm,  $z=342$  mm

Concrete area in compression:  $A_{c,comp} = 77,490$  mm<sup>2</sup>

$$\sqrt{M_{Ed,x}^2 + M_{Ed,y}^2}/N_{Ed} = \sqrt{150^2 + 90^2}/250 = 0.7 < 3.5$$

The interface is subjected to predominant compression/shear

$$v_{Edi} \leq v_{Rdi}$$

EC2-1-1, eq. (6.23)

$$v_{Edi} = V_{Ed}/A_{c,comp}$$

$$V_{Ed} = \sqrt{V_{Ed,x}^2 + V_{Ed,y}^2}/A_{c,comp} = 10^3 \cdot \sqrt{45^2 + 75^2}/77,490 = 1.13 \text{ N/mm}^2$$

$$v_{Rdi} = c \cdot f_{ctd} + \mu \cdot \sigma_n + \mu \cdot \rho \cdot f_{yd} \leq 0.5 \cdot v \cdot f_{cd}$$

 EC2-1-1, eq. (6.25) with  $\alpha = 90^\circ$ 

$$f_{ctd} = \alpha_{ct} \cdot f_{ctk,0.05}/\gamma_c = \alpha_{ct} \cdot 0.7 \cdot 0.3 \cdot f_{ck}^{2/3}/\gamma_c = 0.85 \cdot 0.21 \cdot 25^{2/3}/1.5 = 1.02 \text{ N/mm}^2$$

EC2-1-1, eq. (6.16) + tab. 3.1

$$\sigma_n = F_{Ed,comp}/A_{c,comp} = 8.15 \leq 0.6 \cdot f_{cd} = 8.5 \text{ N/mm}^2$$

EC2-1-1, Sect. 6.2.5 (1)

$$\rho = A_s/A_{c,comp} = 0 \quad (\text{longitudinal reinforcement not taken into account})$$

EC2-1-1, Sect. 6.2.5 (1)

$$v = 0.6 \cdot (1 - f_{ck}/250) = 0.6 \cdot (1 - 25/250) = 0.54$$

EC2-1-1, eq. (6.6N)

$$f_{cd} = \alpha_{cc} \cdot f_{ck}/\gamma_c = 0.85 \cdot 25/1.5 = 14.17 \text{ N/mm}^2$$

EC2-1-1, eq. (3.15)

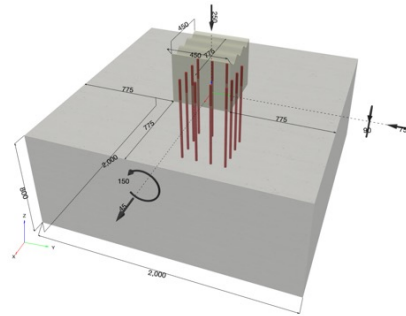

Fig. 7.14: Column-to-foundation connection

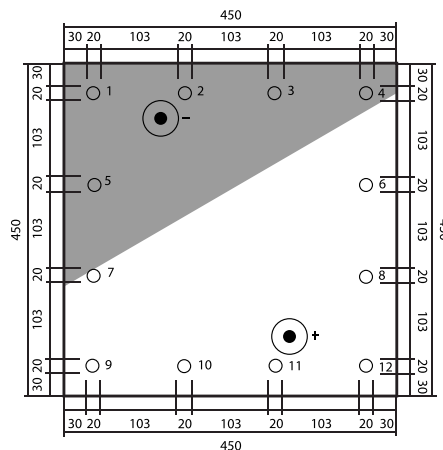

Fig. 7.15: Cross-section analysis of column

$v_{Rdi} = 0.4 \cdot 1.02 + 0.7 \cdot 8.15 = 6.11 > 0.5 \cdot 0.54 \cdot 14.17$  the resistance of compressive strut is decisive

$3.83 \rightarrow 3.83 \text{ N/mm}^2 > v_{Edi} = 1.13 \text{ N/mm}^2$

Verification fulfilled ✓

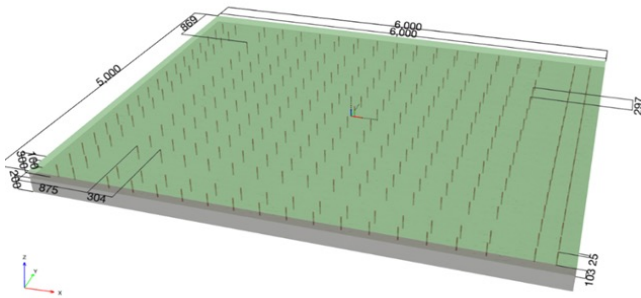

Fig. 7.16: Shear overlay static – schematic example

### 7.6.3 Overlay – static design example

**Project requirement:** In the following, it is presented an example about the design of the connection between an existing concrete slab and an overlay of an industrial floor.

Relevant project information:

Geometry:	Thickness of the existing slab, $h_{ex} = 200 \text{ mm}$ Thickness of the overlay, $h_{ov} = 100 \text{ mm}$ Net cover on top/bottom of the slab, $c_s = 20 \text{ mm}$ Width of the slab, $w = 5,000 \text{ mm}$ Span length, $l = 6,000 \text{ mm}$
Materials:	Existing slab concrete class, C30/37 Overlay concrete class, C40/40 Surface treatment: sandblasting, rough ( $\geq 1.5 \text{ mm}$ ) Cracked concrete with sufficient reinforcement to limit the crack width to $0.3 \text{ mm}$
Design action:	Maximum shear acting perpendicular to the interface, $V_{Ed} = 500 \text{ kN}$ Ratio of sustained load, $\alpha_{sus} = 0.6 < \psi_{sus} = 0.88 \rightarrow \psi_{sus} = 1.0$
Interface reinforcement:	Type of connector: HCC-B 14-180 (incl. Mortar HIT-RE500 V4), ETA-18/1022 [46]
Drilling method/orientation:	Rotary-hammer drilling / vertical downwards
Installation / in-service temp.:	20°C / 20°C (Long term) / 40°C (Short term)
Condition of base material:	Dry
Spacing in central areas:	$s_x = s_y = 300 \text{ mm} \rightarrow \rho = 0.0011$
Number of rows on the perimeter:	$n = 2$
Effective embedment in existing concrete, $h_{ef,ex}$	$h_{ef,ex} = 97 \text{ mm}$
Effective embedment the overlay, $h_{ef,ov}$	$h_{ef,ov} = 75 \text{ mm}$

Verification of central area of the slab

Determination of longitudinal shear:

$$\tau_{Ed} = V_{Ed} / (z \cdot b_j) = 500 / [0.9 \cdot (300 - 25) \cdot 5000] = 0.40 \text{ N/mm}^2$$

Determination of the maximum steel stress in the shear connectors (i.e.  $\sigma_s$ , in eq. (2.11) of EOTA TR 066 [4])Verifications in the existing concrete

Steel failure:

$$N_{Rd,s} = N_{Rk,s} / \gamma_{Ms} = 54.8 / 1.5 = 36.5 \text{ kN}$$

Combined pullout-concrete cone failure

$$N_{Rd,p,ex} = N_{Rk,p,ex} / \gamma_{Mc} \quad \text{EC2-4, tab. 7.1}$$

$$N_{Rk,p,ex} = N_{Rk,p,ex}^0 \cdot A_{p,N} / A_{p,N}^0 \cdot \psi_{g,Np} \cdot \psi_{s,Np} \cdot \psi_{re,Np} \quad \text{EC2-4, eq. (7.13)}$$

$$N_{Rk,p,ex}^0 = \psi_{sus} \cdot \tau_{Rk} \cdot \pi \cdot d \cdot h_{ef,ex} = 1.0 \cdot 8.9 \cdot \pi \cdot 14 \cdot 97 = 38.0 \text{ kN} \quad \text{EC2-4, eq. (7.14) + ETA-18/1022}$$

$$s_{cr,Np} = 7.3 \cdot d \cdot \sqrt{\psi_{sus} \cdot \tau_{Rk}} = 7.3 \cdot 14 \cdot \sqrt{1.0 \cdot 8.9} = 305 \rightarrow 3 \cdot h_{ef} = 291 \text{ mm} \quad \text{EC2-4, eq. (7.15)}$$

$$A_{c,Np} = A_{c,Np}^0 = s_{cr,Np}^2 = 84,681 \text{ mm}^2 \quad \text{EC2-4, eq. (7.15) + ETA-18/1022}$$

$$\psi_{g,Np} = 1.0 \quad (s > s_{cr,Np}) \quad \text{EC2-4, sect. 7.2.1.6 (3)}$$

$$\psi_{s,Np} = 0.7 + 0.3 \cdot c / c_{cr,Np} \leq 1.0 \rightarrow 1.0 \quad (c > c_{cr,Np}) \quad \text{EC2-4, eq. (7.20)}$$

$$\psi_{re,Np} = 1.0 \quad \text{no dense reinforcement according to EC2-1-1, sect. 7.2.1.7 (2)}$$

$$N_{Rd,p,ex} = N_{Rk,p,ex}^0 \cdot A_{p,N} / A_{p,N}^0 \cdot \psi_{g,Np} \cdot \psi_{s,Np} \cdot \psi_{re,Np} = 38.0 / 1.5 = 25.3 \text{ kN}$$

Concrete cone failure

$$N_{Rd,c,ex} = N_{Rk,c,ex} / \gamma_{Mc} \quad \text{EC2-4, tab. 7.1}$$

$$N_{Rk,c,ex} = N_{Rk,c,ex}^0 \cdot A_{c,N} / A_{c,N}^0 \cdot \psi_{s,N} \cdot \psi_{re,N} \quad \text{EC2-4, eq. (7.1)}$$

$$N_{Rk,c,ex}^0 = k_1 \cdot \sqrt{f_{ck}} \cdot h_{ef,ex}^{1.5} = 7.7 \cdot \sqrt{30} \cdot 97^{1.5} = 40.3 \text{ kN} \quad \text{EC2-4, eq. (7.2)}$$

$$A_{c,N} = A_{c,N}^0 = s_{cr,N}^2 = 84,681 \text{ mm}^2 \quad \text{EC2-4, eq. (7.3)}$$

$$\psi_{s,N} = 0.7 + 0.3 \cdot c / c_{cr,N} \leq 1.0 \rightarrow 1.0 \quad (c > c_{cr,N}) \quad \text{EC2-4, eq. (7.4)}$$

$$N_{Rd,c,ex} = N_{Rk,c,ex}^0 \cdot A_{c,N} / A_{c,N}^0 \cdot \psi_{s,N} \cdot \psi_{re,N} = 40.3 / 1.5 = 26.9 \text{ kN}$$

Verifications in the overlay

Pullout failure

$$N_{Rd,p,ov} = N_{Rk,p} / \gamma_{Mp} \quad \text{EC2-4, tab. 7.1}$$

$$N_{Rk,p,ov} = k_2 \cdot A_n \cdot f_{ck} = 7.5 \cdot 1,140 \cdot 40 = 342 \text{ kN} \quad \text{EC2-4, eq. (7.11) + ETA-18/1022}$$

$$N_{Rd,p,ov} = 213.8 / 1.5 = 228 \text{ kN}$$

Concrete cone failure

$$N_{Rd,c,ov} = N_{Rk,c,ov} / \gamma_{Mc} \quad \text{EC2-4, tab. 7.1}$$

$$N_{Rk,c,ov} = N_{Rk,c,ov}^0 \cdot A_{c,N} / A_{c,N}^0 \cdot \psi_{s,N} \cdot \psi_{re,N} \quad \text{EC2-4, eq. (7.1)}$$

$$N_{Rk,c,ov}^0 = k_1 \cdot \sqrt{f_{ck}} \cdot h_{ef,ov}^{1.5} = 8.9 \cdot \sqrt{40} \cdot 75^{1.5} = 36.6 \text{ kN} \quad \text{EC2-4, eq. (7.2)}$$

$$A_{c,N} = A_{c,N}^0 = s_{cr,N}^2 = 9 \cdot h_{ef,ov}^2 = 9 \cdot 75^2 = 50,625 \text{ mm}^2 \quad \text{EC2-4, eq. (7.3)}$$

$$\psi_{s,N} = 0.7 + 0.3 \cdot c / c_{cr,N} \leq 1.0 \rightarrow 1.0 \quad (c > c_{cr,N}) \quad \text{EC2-4, eq. (7.4)}$$

$$N_{Rd,c,ov} = N_{Rk,c,ov}^0 \cdot A_{c,N} / A_{c,N}^0 \cdot \psi_{s,N} \cdot \psi_{re,N} = 36.6 / 1.5 = 24.4 \text{ kN}$$

$$\sigma_s = \min\{N_{Rd,s}; N_{Rd,p,ex}; N_{Rd,c,ex}; N_{Rd,p,ov}; N_{Rd,c,ov}\} / A_s = \min\{36.5; 25.3; 26.9; 228.0; 24.4\} / 110$$

$$\sigma_s = 222.3 \text{ MPa}$$

Interface shear verification

$$\tau_{Rd} = c_r \cdot f_{ck}^{1/3} + \mu \cdot (\sigma_n + \kappa_1 \cdot \alpha_{\kappa 1} \cdot \rho \cdot \sigma_s) + \kappa_2 \cdot \alpha_{\kappa 2} \cdot \rho \cdot \sqrt{\frac{f_{y,k}}{\gamma_s} \cdot \frac{0,85 \cdot f_{ck}}{\gamma_c}} \quad \text{EOTA TR 066, eq. (2.11) + tab. 2.2}$$

$$\tau_{Rd} = 0.1 \cdot 30^{1/3} + 0.7 \cdot (0.5 \cdot 0.8 \cdot 0.0011 \cdot 222.3) + 0.9 \cdot 1.3 \cdot 0.0011 \cdot \sqrt{\frac{400}{1.15} \cdot \frac{0.85 \cdot 30}{1.5}} = 0.47 \text{ N/mm}^2$$

$$\tau_{Rd} > \tau_{Ed}$$

Verification fulfilled ✓

Verification of perimetral area of the slab

Cracking force:

$$V_{Ed,j}^* = h_{new} \cdot b_j \cdot f_{ctd} = 100 \cdot 1000 \cdot 1.64 = 164.0 \text{ kN/m} \quad \text{EOTA TR 066, eq. (2.2)}$$

$$\tau_{Ed}^* = \frac{V_{Ed,j}^*}{l_e \cdot b_j} = h_{new} \cdot \frac{f_{ctd}}{l_e} = 100 \cdot \frac{1.64}{600} = 0.27 \text{ N/mm}^2 \quad \text{EOTA TR 066, eq. (2.3)}$$

$$\tau_{Ed}^* = 0.27 \text{ N/mm}^2 < \tau_{Ed} = 0.40 \text{ N/mm}^2 \quad \text{Verification fulfilled ✓}$$

Tension force due to uplift force:

$$N_{Ed,j}^* = V_{Ed,j}^* / 6 = 164 / 6 = 27.3 \text{ kN/m} \quad \text{EOTA TR 066, eq. (2.4)}$$

$$n = (l_e \cdot 1000 \text{ mm}) / (s_x \cdot s_y) = (600 \cdot 1000) / (300 \cdot 300) = 6.67 \rightarrow 6 \quad \text{No. of connectors in 1 m on edge}$$

$$N_{Rd} = n \cdot N_{Rd,min} = n \cdot N_{Rd,c,ov} = 6 \cdot 24.4 = 146.4 \text{ kN/m} > N_{Ed,j}^* = 27.3 \text{ kN/m} \quad \text{Verification fulfilled ✓}$$

#### 7.6.4 Overlay – fatigue design example

Project requirement: in the same industrial floor strengthened in the previous example, machines inducing a fatigue action should be installed.

According to EOTA TR 066 [4], Table 1.1 the interface roughness class should be “very rough” or “indented” (i.e.,  $\geq 3 \text{ mm}$ ). For the following calculation it is assumed that this requirement is fulfilled.

Design fatigue actions:  $V_{Ed,min} = 300 \text{ kN}$ ;  $V_{Ed,max} = 400 \text{ kN} \rightarrow$  pulsating action

$$\tau_{Ed,min} = V_{Ed,min} / (z \cdot b_j) = 300 / [0.9 \cdot (300 - 25) \cdot 5000] = 0.24 \text{ N/mm}^2 \quad \text{EOTA TR 066, eq. (2.1)}$$

$$\tau_{Ed,max} = V_{Ed,max} / (z \cdot b_j) = 400 / [0.9 \cdot (300 - 25) \cdot 5000] = 0.32 \text{ N/mm}^2 \quad \text{EOTA TR 066, eq. (2.1)}$$

$$\Delta \tau_{Ed} = \tau_{Ed,max} - \tau_{Ed,min} = 0.08 \text{ N/mm}^2 \quad \text{EOTA TR 066, eq. (2.16)}$$

$$\tau_{Ed,max} / \tau_{Rd} \leq \eta_{sc} + 0.55 \cdot \tau_{Ed,min} / \tau_{Rd} \leq 0.9 \quad \text{EOTA TR 066, eq. (2.17a)}$$

$$\tau_{Rd} = 0.2 \cdot 30^{1/3} + 0.8 \cdot (0.5 \cdot 0.9 \cdot 0.0011 \cdot 222.3) + 0.9 \cdot 1.3 \cdot 0.0011 \cdot \sqrt{\frac{400}{1.15} \cdot \frac{0.85 \cdot 30}{1.5}} = 0.80 \text{ N/mm}^2$$

$$0.32 / 0.80 \leq 0.40 + 0.55 \cdot 0.24 / 0.80 \leq 0.9 \rightarrow 0.40 \leq 0.57 \leq 0.9 \quad \text{Verification fulfilled ✓}$$

$$\tau_{Ed,min} / \tau_{Rd} \leq 0.9 \rightarrow 0.24 / 0.80 = 0.3 \leq 0.9 \quad \text{EOTA TR 066, eq. (2.17a), verification fulfilled ✓}$$

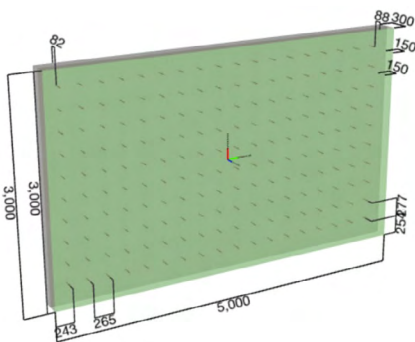

Fig. 7.17: Wall shear overlay - schematic example

### 7.6.5 Overlay – seismic example

Project requirement: increase thickness of existing shear-infill wall.

Relevant project information:

Geometry:	Thickness of the existing slab, $h_{ex}=150\text{ mm}$ Thickness of the overlay, $h_{ov}=150\text{ mm}$ Net side cover of the wall, $c_s=20\text{ mm}$ Width of the wall, $w=5,000\text{ mm}$ Height of the wall, $h=3,000\text{ mm}$
Materials:	Existing slab concrete class, C25/30 Overlay concrete class, C30/37 Surface treatment: sandblasting, rough ( $\geq 1.5\text{ mm}$ ) Cracked concrete as per seismic category C1
Design action:	Maximum shear stress acting perpendicular to the interface, $\tau_{Ed}=0.3\text{ N/mm}^2$
Interface reinforcement:	Type of connector: HUS4-H 10x150 (ETA-21/0969 [47]) Drilling method/orientation: rotary-hammer drilling / horizontal Spacing in central areas: $s_x = s_y = 250\text{ mm} \rightarrow \rho = 0.0008$ Effective embedment in existing concrete, $h_{ef,ex} = 68\text{ mm}$ Effective embedment the overlay, $h_{ef,ov} = 62\text{ mm}$

Determination of the maximum steel stress in the shear connectors (i.e.,  $\sigma_s$ , in eq. (2.11) of EOTA TR 066)

#### Verifications in the existing concrete

##### Steel failure

$$N_{Rd,s,eq} = N_{Rk,s,eq} / \gamma_{Ms,eq} \quad \text{EC2-4, Table 7.1, Annex C, sect. C.5}$$

$$N_{Rd,s,eq} = \alpha_{gap} \cdot \alpha_{eq} \cdot N_{Rk,s} / \gamma_{Ms,eq} = 1.0 \cdot 1.0 \cdot 55.0 / 1.5 = 36.7\text{ kN} \quad \text{EN 1992-4, eq. (C.8)}$$

##### Pullout failure

$$N_{Rd,p,eq,ex} = N_{Rk,p,eq,ex} / \gamma_{Mc,eq} \quad \text{EC2-4, Table 7.1, Annex C, sect. C.5}$$

$$N_{Rd,p,eq,ex} = \alpha_{gap} \cdot \alpha_{eq} \cdot N_{Rk,p} / \gamma_{Ms,eq} = 1.0 \cdot 0.85 \cdot 16.4 / 1.5 = 9.3\text{ kN} \quad \text{EN 1992-4, eq. (C.8)}$$

##### Concrete cone failure

$$N_{Rd,c,ex} = N_{Rk,c,eq,ex} / \gamma_{Mc,eq} \quad \text{EC2-4, Table 7.1, Annex C, sect. C.5}$$

$$N_{Rk,c,ex} = \alpha_{gap} \cdot \alpha_{eq} \cdot N_{Rk,c,ex}^0 \cdot A_{c,N} / A_{c,N}^0 \cdot \psi_{s,N} \cdot \psi_{re,N} \quad \text{EC2-4, eq. (7.1) and eq. (C.8)}$$

$$N_{Rk,c,ex}^0 = k_1 \cdot \sqrt{f_{ck}} \cdot h_{ef,ex}^{1.5} = 7.7 \cdot \sqrt{25} \cdot 68^{1.5} = 21.6\text{ kN} \quad \text{EC2-4, eq. (7.2)}$$

$$A_{c,N} = A_{c,N}^0 = s_{cr,N}^2 = 9 \cdot 68^2 = 41,616\text{ mm}^2 \quad \text{EC2-4, eq. (7.3)}$$

$$\psi_{s,Np} = 0.7 + 0.3 \cdot c / c_{cr,N} \leq 1.0 \rightarrow 1.0 \quad (c > c_{cr,N}) \quad \text{EC2-4, eq. (7.4)}$$

$$\psi_{re,Np} = 1.0 \quad \text{no dense reinforcement according to EC2-1-1, Sect. 7.2.1.7 (2)}$$

$$N_{Rd,c,ex} = \alpha_{gap} \cdot \alpha_{eq} \cdot N_{Rk,c}^0 \cdot A_{c,N} / A_{c,N}^0 \cdot \psi_{s,N} \cdot \psi_{re,N} = 1.0 \cdot 0.85 \cdot 21.6 / 1.5 = 12.2\text{ kN}$$

#### Verifications in the overlay

##### Pullout failure

$$N_{Rd,p,eq,ov} \geq N_{Rd,c,eq,ov}^0 \quad \text{ETA-21/0969}$$

##### Concrete cone failure

$$N_{Rd,c,ov} = N_{Rk,c,eq,ov} / \gamma_{Mc,eq} \quad \text{EC2-4, Table 7.1, Annex C, sect. C.5}$$

$$N_{Rk,c,ov} = \alpha_{gap} \cdot \alpha_{eq} \cdot N_{Rk,c}^0 \cdot A_{c,N} / A_{c,N}^0 \cdot \psi_{s,N} \cdot \psi_{re,N} \quad \text{EC2-4, eq. (7.1) and eq. (C.8)}$$



$$N_{Rk,c,ov}^0 = \alpha_{gap} \cdot \alpha_{eq} \cdot k_1 \cdot \sqrt{f_{ck}} \cdot h_{ef,ov}^{1.5} = 8.9 \cdot \sqrt{30} \cdot 62^{1.5} = 23.8 \text{ kN} \quad \text{EC2-4, eq. (7.2)}$$

$$A_{c,N} = A_{c,N}^0 = s_{cr,N}^2 = 9 \cdot h_{ef,ov}^2 = 9 \cdot 62^2 = 34,596 \text{ mm}^2 \quad \text{EC2-4, eq. (7.3)}$$

$$\psi_{s,N} = 0.7 + 0.3 \cdot c/c_{cr,N} \leq 1.0 \rightarrow 1.0 \quad (c > c_{cr,N}) \quad \text{EC2-4, eq. (7.4)}$$

$$N_{Rd,c,ov} = \alpha_{gap} \cdot \alpha_{eq} \cdot N_{Rk,c,ov}^0 \cdot A_{c,N}/A_{c,N}^0 \cdot \psi_{s,N} \cdot \psi_{re,N} = 1.0 \cdot 1.0 \cdot 23.8/1.5 = 15.9 \text{ kN}$$

$$\sigma_s = \min\{N_{Rd,s}; N_{Rd,p,ex}; N_{Rd,c,ex}; N_{Rd,p,ov}; N_{Rd,c,ov}\}/A_s = \min\{36.7; 9.3; 12.2; 15.9\}/69 = 135 \text{ MPa}$$

Interface shear verification

$$\tau_{Rd} = \alpha_{eq} \cdot \left[ \mu \cdot (\sigma_n + \kappa_1 \cdot \alpha_{\kappa 1} \cdot \rho \cdot \sigma_s) + \kappa_2 \cdot \alpha_{\kappa 2} \cdot \rho \cdot \sqrt{\frac{f_{yk}}{\gamma_s} \cdot \frac{f_{ck}}{\gamma_c}} \right] \leq \beta_c \cdot v \cdot \frac{f_{ck}}{\gamma_c} \quad \text{EOTA TR 066, eq. (3.2)}$$

$$\mu = 0.4 \cdot \sqrt[3]{(f_{cd}/(\rho \cdot \sigma_s + \sigma_n))^2} = 0.4 \cdot \sqrt[3]{((25/1.5)/(0.0008 \cdot 135))^2} = 11.5 \quad \text{EOTA TR 066, tab. 3.2}$$

$$\tau_{Rd} = 0.5 \cdot \left[ 11.5 \cdot (0.5 \cdot 0.8 \cdot 0.0008 \cdot 135) + 0.9 \cdot 1.0 \cdot 0.0008 \cdot \sqrt{\frac{639}{1.15} \cdot \frac{25}{1.5}} \right] = 0.3 \text{ N/mm}^2$$

$$\tau_{Rd} = \tau_{Ed}$$

Verification fulfilled 

### 7.6.6 Overlay – Hilti method example

The same design example as above is now resolved using the Hilti Method:

Interface reinforcement: Type of connector: PIR  $\phi 10$  with Mortar HIT-RE500 V4,  
ETA-20/0541 [48],  $f_{yk} = 450 \text{ N/mm}^2$

Drilling method/orientation: rotary-hammer drilling / horizontal

Spacing in central areas:  $s_x = s_y = 250 \text{ mm} \rightarrow \rho = 0.0008$

Effective embedment in existing concrete,  $h_{ef,ex} = 100 \text{ mm}$

Effective embedment the overlay,  $h_{ef,ov} = 100 \text{ mm}$

Determination of the maximum steel stress in the shear connectors (i.e.,  $\sigma_s$ , in eq. (2.11) of EOTA TR 066 [4])

#### Verifications in the existing concrete

Steel failure

$$N_{Rd,s,eq} = N_{Rk,s,eq}/\gamma_{Ms,eq} \quad \text{EC2-4, Table 7.1, Annex C, sect. C.5}$$

$$N_{Rd,s,eq} = \alpha_{gap} \cdot \alpha_{eq} \cdot N_{Rk,s}/\gamma_{Ms,eq} = 1.0 \cdot 1.0 \cdot 42.4/1.4 = 30.3 \text{ kN} \quad \text{EC2-4, eq. (C.8)}$$

Combined pullout-concrete cone failure

$$N_{Rd,p,ex} = N_{Rk,p,ex}/\gamma_{Mc} \quad \text{EC2-4, tab. 7.1}$$

$$N_{Rk,p,ex} = N_{Rk,p,ex}^0 \cdot A_{p,N}/A_{p,N}^0 \cdot \psi_{g,Np} \cdot \psi_{s,Np} \cdot \psi_{re,Np} \quad \text{EC2-4, eq. (7.13)}$$

$$N_{Rk,p,ex}^0 = \psi_{sus} \cdot \tau_{Rk} \cdot \pi \cdot d \cdot h_{ef,ex} = 1.0 \cdot 9.1 \cdot \pi \cdot 10 \cdot 100 = 28.6 \text{ kN} \quad \text{EC2-4, eq. (7.14) + ETA-20/0541}$$

$$s_{cr,Np} = 7.3 \cdot d \cdot \sqrt{\psi_{sus} \cdot \tau_{Rk}} = 7.3 \cdot 10 \cdot \sqrt{1.0 \cdot 9.1} = 220 \text{ mm} \quad \text{EC2-4, eq. (7.15) + ETA-20/0541}$$

$$A_{c,Np} = A_{c,Np}^0 = s_{cr,Np}^2 = 220^2 = 48,400 \text{ mm}^2 \quad \text{EC2-4, eq. (7.15) + ETA-18/1022}$$

$$\psi_{g,Np} = 1.0 \quad (s > s_{cr,Np}) \quad \text{EC2-4, sect. 7.2.1.6 (3)}$$

$$\psi_{s,Np} = 0.7 + 0.3 \cdot c/c_{cr,Np} \leq 1.0 \rightarrow 1.0 \quad (c > c_{cr,Np}) \quad \text{EC2-4, eq. (7.20)}$$

$$\psi_{re,Np} = 1.0 \quad \text{no dense reinforcement according to EC2-1-1, sect. 7.2.1.7 (2)}$$

$$N_{Rd,p,ex} = \alpha_{gap} \cdot \alpha_{eq} \cdot N_{Rk,p,ex}^0 \cdot A_{p,N}/A_{p,N}^0 \cdot \psi_{g,Np} \cdot \psi_{s,Np} \cdot \psi_{re,Np} = 1.0 \cdot 0.85 \cdot 28.6/1.5 = 12.2 \text{ kN}$$

## Concrete cone failure

$$N_{Rd,c,ex} = N_{Rk,c,eq,ex} / \gamma_{Mc,eq} \quad \text{EC2-4, Table 7.1, Annex C, sect. C.5}$$

$$N_{Rk,c,ex} = \alpha_{gap} \cdot \alpha_{eq} \cdot N_{Rk,c,ex}^0 \cdot A_{c,N} / A_{c,N}^0 \cdot \psi_{s,N} \cdot \psi_{re,N} \quad \text{EC2-4, eq. (7.1) and eq. (C.8)}$$

$$N_{Rk,c,ex}^0 = k_1 \cdot \sqrt{f_{ck}} \cdot h_{ef,ex}^{1.5} = 7.7 \cdot \sqrt{25} \cdot 100^{1.5} = 38.5 \text{ kN} \quad \text{EC2-4, eq. (7.2)}$$

$$A_{c,N}^0 = s_{cr,N}^2 = 9 \cdot 100^2 = 90,000 \text{ mm}^2 \quad \text{EC2-4, eq. (7.3)}$$

$$A_{c,N} = s_x \cdot s_y = 250^2 = 62,500 \text{ mm}^2$$

$$\psi_{s,Np} = 0.7 + 0.3 \cdot c / c_{cr,N} \leq 1.0 \rightarrow 1.0 \quad (c > c_{cr,N}) \quad \text{EC2-4, eq. (7.4)}$$

$$\psi_{re,Np} = 1.0 \quad \text{no dense reinforcement according to EC2-4, sect. 7.2.1.7 (2)}$$

$$N_{Rd,c,ex} = \alpha_{gap} \cdot \alpha_{eq} \cdot N_{Rk,c}^0 \cdot A_{c,N} / A_{c,N}^0 \cdot \psi_{s,N} \cdot \psi_{re,N} = 1.0 \cdot 0.75 \cdot \left( \frac{62,500}{90,000} \right) \cdot 38.5 / 1.5 = 13.4 \text{ kN}$$

## Verifications in the overlay

## Pullout failure

$$N_{Rd,p,eq,ov} = N_{Rk,p,eq,ov} / \gamma_{Mp,eq} \quad \text{EC2-4, Annex C, sect. C.5}$$

$$N_{Rd,p,eq,ov} = \alpha_{gap} \cdot \alpha_{eq} \cdot k_2 \cdot A_h \cdot f_{ck} = 1.0 \cdot 0.85 \cdot 7.5 \cdot 236 \cdot 30 / 1.5 = 30.0 \text{ kN}$$

## Concrete cone failure

$$N_{Rd,c,ov} = N_{Rk,c,eq,ov} / \gamma_{Mc,eq} \quad \text{EC2-4, Table 7.1, Annex C, sect. C.5}$$

$$N_{Rk,c,ov} = \alpha_{gap} \cdot \alpha_{eq} \cdot N_{Rk,c}^0 \cdot A_{c,N} / A_{c,N}^0 \cdot \psi_{s,N} \cdot \psi_{re,N} \quad \text{EC2-4, eq. (7.1) and eq. (C.8)}$$

$$N_{Rk,c,ov}^0 = k_1 \cdot \sqrt{f_{ck}} \cdot h_{ef,ov}^{1.5} = 1.0 \cdot 0.85 \cdot 8.9 \cdot \sqrt{30} \cdot 100^{1.5} = 48.7 \text{ kN} \quad \text{EC2-4, eq. (7.2)}$$

$$A_{c,N}^0 = s_{cr,N}^2 = 9 \cdot h_{ef,ov}^2 = 9 \cdot 100^2 = 90,000 \text{ mm}^2 \quad \text{EC2-4, eq. (7.3)}$$

$$A_{c,N} = s_x \cdot s_y = 250^2 = 62,500 \text{ mm}^2$$

$$\psi_{s,N} = 0.7 + 0.3 \cdot c / c_{cr,N} \leq 1.0 \rightarrow 1.0 \quad (c > c_{cr,N}) \quad \text{EC2-4, eq. (7.4)}$$

$$N_{Rd,c,ov} = \alpha_{gap} \cdot \alpha_{eq} \cdot N_{Rk,c,ov}^0 \cdot A_{c,N} / A_{c,N}^0 \cdot \psi_{s,N} \cdot \psi_{re,N} = 1.0 \cdot 0.85 \cdot \frac{65,000}{90,000} \cdot 48.7 / 1.5 = 19.9 \text{ kN}$$

$$\sigma_s = \min\{N_{Rd,s}; N_{Rd,p,ex}; N_{Rd,c,ex}; N_{Rd,p,ov}; N_{Rd,c,ov}\} / A_s = \min\{30.3; 12.2; 13.4; 30.0; 19.9\} / 78.5 = 156 \text{ MPa}$$

## Interface shear verification

$$\tau_{Rd} = \mu_h \cdot (\sigma_n + \kappa_{1h} \cdot \rho \cdot \sigma_s) + \kappa_{2h} \cdot \rho \cdot \sqrt{\frac{f_{y,k}}{\gamma_s} \cdot \frac{f_{ck}}{\gamma_c}} \leq \beta_c \cdot v \cdot \frac{f_{ck}}{\gamma_c} \quad \text{Sect. 7.5}$$

$$\mu_h = 0.3 \cdot \sqrt[3]{(f_{cd} / (\rho \cdot \sigma_s + \sigma_n))^2} = 0.4 \cdot \sqrt[3]{((25 / 1.5) / (0.0008 \cdot 156))^2} = 7.8 \quad \text{Sect. 7.5}$$

$$\tau_{Rd} = 7.8 \cdot 0.4 \cdot 0.0008 \cdot 156 + 0.7 \cdot 0.0008 \cdot \sqrt{\frac{450}{1.15} \cdot \frac{25}{1.5}} = 0.39 \text{ N/mm}^2$$

$$\tau_{Rd} = 0.39 \text{ N/mm}^2 > \tau_{Ed} = 0.3 \text{ N/mm}^2 \quad \text{Verification fulfilled} \quad \checkmark$$

**Note:** The comparison between the solutions obtained for this application with a design according to EOTA TR 066 [2] and the Hilti Method using shear connectors with similar diameter and spacing shows the higher resistance obtained with the Hilti Method (i.e., utilization of 77% vs. 100%). However, the post-installed rebar elements require a larger embedment in both new and existing concretes in comparison to the HUS4-H solution (i.e., 100 mm vs. 62 & 68 mm).

## 8. PROFIS ENGINEERING SUITE – SOFTWARE DESIGN

### 8.1 Introduction

Hilti PROFIS Engineering Suite (PROFIS) is a structural engineering design software. It has a range of features that allow engineers to create code-compliant designs of connection between concrete elements cast at different times using post-installed rebars or shear connectors. The design covers a range of applications including lap splices, end anchorages and shear-friction (overlay) applications. PROFIS also helps in creating detailed and safe specifications for the jobsite. The various design methods discussed in the previous chapters can be very time consuming, especially when creating manual calculations and comparing different solutions. PROFIS helps designers to quickly create code-compliant designs, ensuring a safer and efficient workflow.

PROFIS also includes features for visualizing and communicating the design, such as 3D displaying of forces and structural components and 2D cross-section drawings showing required detailing and design reports showing detailed calculations. Other attributes include analyzing the performance of a connection for different ETA-qualified products, various load conditions such as static, seismic and fire loads, and their efficiency (i.e., utilization ratio) for optimizing designs instantly.

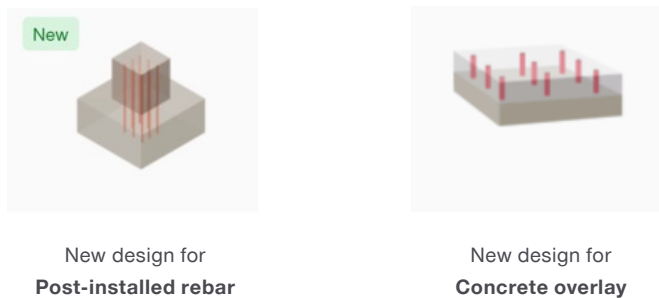

Note: PROFIS offers instant, efficient, and accurate solutions for concrete connections.



Fig. 8.1: PROFIS Engineering Suite modules for post-installed concrete-to-concrete applications

### 8.2 Why use PROFIS Engineering Suite?

**One stop solution:** PROFIS is a single platform for the design of various types of applications using post-installed systems (rebars and shear connectors) from defining the model to creating design outputs (see Fig. 8.2). All applications discussed in [chapter 2](#) can be designed using PROFIS in a very efficient, quick, accurate and transparent way. Design methods such as Eurocode, EOTA TR 069 [2], the Hilti Method, etc. can be compared in PROFIS in a quick way to find the optimal solution. PROFIS also allows the use of several national design standards such as European, American, and other national/regional standards.

	<p><b>Be Compliant</b></p> <ul style="list-style-type: none"> <li>✓ Latest Regulatory frameworks EU, ACI, etc.</li> <li>✓ Shear design options</li> <li>✓ Comprehensive report output</li> </ul>	<p><b>Save Costs</b></p> <ul style="list-style-type: none"> <li>✓ Cost-effective solutions</li> <li>✓ Material savings with optimum design</li> <li>✓ Optional existing reinforcement selection</li> </ul>
	<p><b>Save Time</b></p> <ul style="list-style-type: none"> <li>✓ Fast and easy calculation</li> <li>✓ Simultaneous design of multiple design methods</li> </ul>	<p><b>Customizable</b></p> <ul style="list-style-type: none"> <li>✓ Customizable positioning of cast-in and post-installed rebars</li> <li>✓ Single rebar module</li> <li>✓ Custom image upload of job site photos or notes in the output report</li> </ul>
<p><b>PROFIS is the first connection design software to cover the complete C2C applications!</b></p>		

Fig. 8.2: Benefits of using PROFIS

### 8.3 Designing post-installed rebar applications using PROFIS

In the following section, the main design steps and features for the design of concrete connections with post-installed rebars are described.

#### Choice of application type

The designer can choose the right connection type (lap splice or end anchorage) and application required from the list of options available in PROFIS Engineering Suite (see Fig. 8.3):

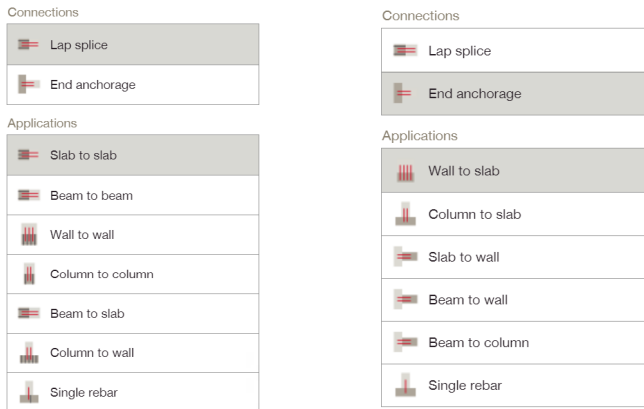

Fig. 8.3: Applications of lap splices and end anchorages in PROFIS

#### Concrete material properties & installation conditions

The next step involves setting up the design material parameters of existing concrete and new concrete grades along with installation conditions. PROFIS offers dropdown options for this (see Fig. 8.4), where the designer/engineer can select the concrete strength in the available range (C12/15 to C50/60).

**Note:** PROFIS allows for entering custom values of concrete material grades (e.g., concrete strength classes higher than C50/60) when technical data are available for a specific product.

**Note:** PROFIS checks the selected drilling type is compatible with all other parameters required by the application.

Installation conditions involve the selection of the working temperature range during an application's design life and temperature range during installation/injection of an adhesive mortar (see Fig. 8.4).

Selection of drilling method, use of drilling aid, condition of drilled holes and concrete surface treatment, as discussed in sect. 9.1.2 and sect. 9.1.3 can also to be defined. This is a part of the design procedure that also affects the selection of a qualified ETA product for design as well as installation parameters. For example: the selected drilling type might be allowed only in combination with a specific mortar system that has a limited range of diameters and embedment depths according to the ETA.

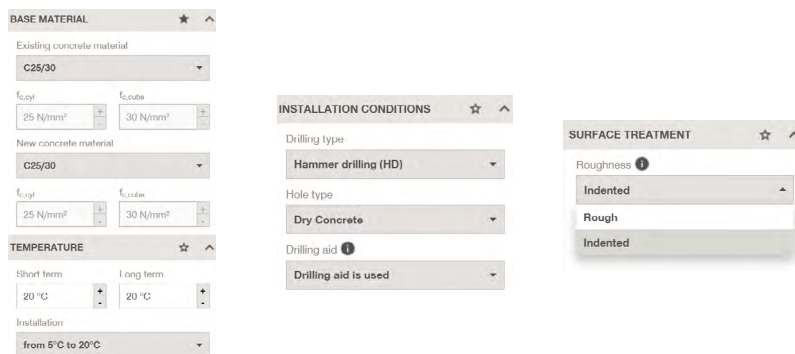

Fig. 8.4: Base material properties and installation conditions

### Existing reinforcement material properties

This step allows the designer to enter information on reinforcement details in existing concrete, such as the material grade, diameter, spacing, shape, cover, bond condition, longitudinal rebar layers details and transverse reinforcement details (mainly required for lap spliced applications, which might help in reducing the lap length). PROFIS allows to enter information of longitudinal and transverse reinforcement either in layers or in cross-section arrangement form (using rebar shape and numbers, diameter, bond condition and concrete cover information (see Fig. 8.5)

The screenshot shows the 'Existing reinforcement properties' configuration window. On the left, there are two tabs: 'TOP LAYER' and 'BOTTOM LAYER'. Below them, the 'Number of layers' is set to 1. The 'Shape' is set to 'Straight' and 'Bond condition' is set to 'Good'. The 'Front cover' is set to 50 mm. On the right, there are two diagrams showing reinforcement layouts. Below them, the 'Shape' is set to 'Hooked' and 'Bond condition' is set to 'Good'. The 'Diameter' is set to 12 mm, 'Number of bars x' is 3, and 'Number of bars y' is 3. The 'Side cover' is set to 35 mm and 'Front cover' is set to 50 mm.

**Note:** PROFIS gives full flexibility in defining stirrups, reinforcement layers (1 to 4 layers) and geometry as per the jobsite condition.

Fig. 8.5: Existing reinforcement properties

### Qualified post-installed material properties (rebar and adhesive mortar)

PROFIS has a feature to define the type of positioning of post-installed rebars in the following two ways for optimization:

**Automatic:** This feature enables the user to find a quick solution that satisfies the loads. An optimized solution proposed by PROFIS is based on the geometry, materials and loading inputs. PROFIS proposes a solution in terms of rebar diameters and spacing. Two possible optimization strategies can be adopted, i.e., minimum numbers of drill holes or minimum rebar diameter.

**User-defined:** The previous option (automatic) is just a starting point. However, the user can define the rebar diameter and spacing for further optimization of the anchorage or lap length.

In both cases the user can choose qualified products (adhesive mortars and shear connectors) based on design and installation requirements (see Fig. 8.6).

The screenshot shows the 'Choosing qualified product solutions' interface. On the left, there is a 'Family' section with a dropdown menu showing 'HIT-HY 200-R V3 + Rebar' and a 'View ETA approval' button. Below this, the 'Adhesive item #' is 2262132 HIT-HY 200-R V3 and the 'Reinforcement yield strength  $f_{yk}$ ' is 500 N/mm<sup>2</sup>. On the right, there is a list of product solutions:

	<b>HIT-HY 200-R V3 + Rebar</b> HIT-HY 200-R V3 injection mortar with Rebar
	<b>HIT-RE 500 V4 + Rebar</b> HIT-RE 500 V4 injection mortar with Rebar
	<b>HIT-FP 700-R + Rebar</b> HIT-FP 700-R injection mortar with Rebar
	<b>HIT-CT 1 + Rebar</b> HIT-CT1 injection mortar with Rebar

Fig. 8.6: Choosing EOTA approved and qualified product solutions

## Defining loads and load types

Different loads can be entered on the 3D-model (see Fig. 8.7) or in the table format, based on the application and connection type (i.e., axial and shear forces as well as bending moments). Load types, design working life, design standards, shear design options, and limits of minimum and maximum reinforcement can also be defined (see Fig. 8.7). Furthermore, PROFIS allows the user to define the input loads either for the entire cross-section or loads per rebar (in this case, no section analysis is performed).

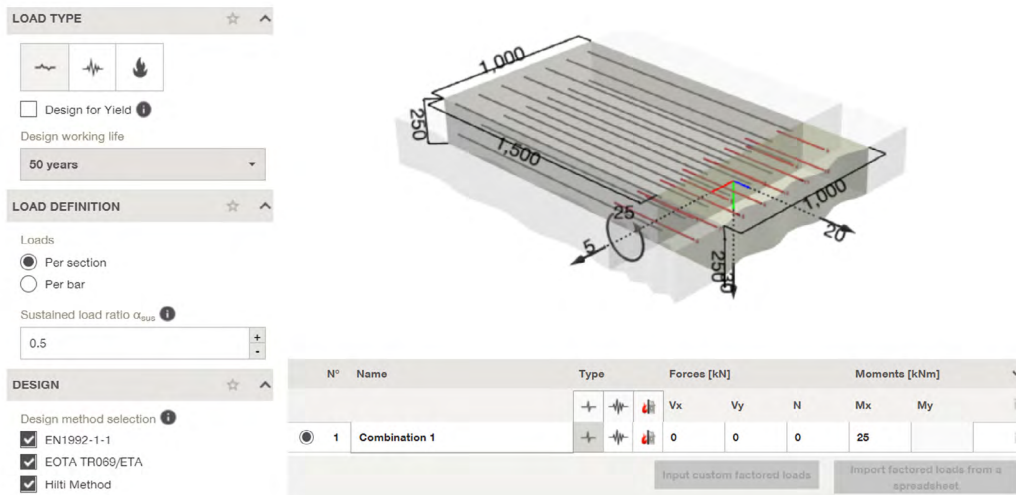

Fig. 8.7: Defining loads and load types in PROFIS

## Choosing design standards & design values

For end anchorage connection designs, PROFIS covers all design methods discussed in this handbook (EC2-1-1 [1], EOTA TR 069 [2], strut-and-tie model method and Hilti method). The installation depth required as a result of each possible design method is calculated and displayed instantly for the designer/engineer to choose from. PROFIS also displays the utilization ratios and its various failure modes as per the selected design method (see Fig. 8.8)

**Note:** Based on input force definition, PROFIS automatically selects the allowed design method. The user can choose the shortest design length or the compliancy with a specific code or design method.

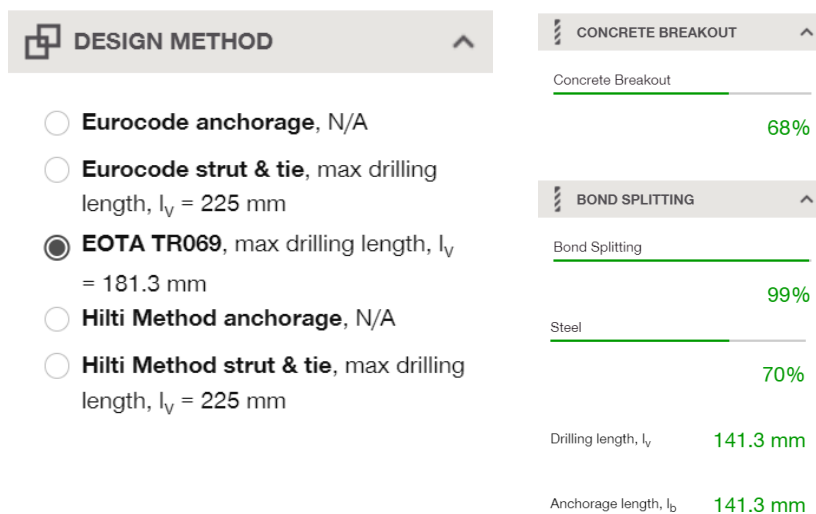

Fig. 8.8: Choice of design solution & corresponding utilization ratios



### Design output (report & drawings)

Once the user has found the preferred design solution, a comprehensive report can be generated at a click of a button. This design output report shows all the input data (geometry, material, loads, etc.) and detailed calculations for all the design checks. The report also shows 3D and 2D sectional drawings with embedment depths that can be used for design specifications. Additionally, warnings and guidelines for installation are also provided in the report.

### 8.3.1 Additional important features in PROFIS

**User-defined editing of rebar diameter and arrangement:** PROFIS offers the ability to completely define the position/layout of both the cast-in and post-installed rebars by the user using the 2D editor option. This editing helps in representing the actual scenario of irregular arrangements and different diameters used in the same layer. The rebar location in the cross-section can be shifted either by using the drag option with the mouse or by giving coordinates for the intended position using the table inputs (see Fig. 8.9)

**Note:** The 2D editor allows customization of rebar arrangements and diameters as per job-site conditions.

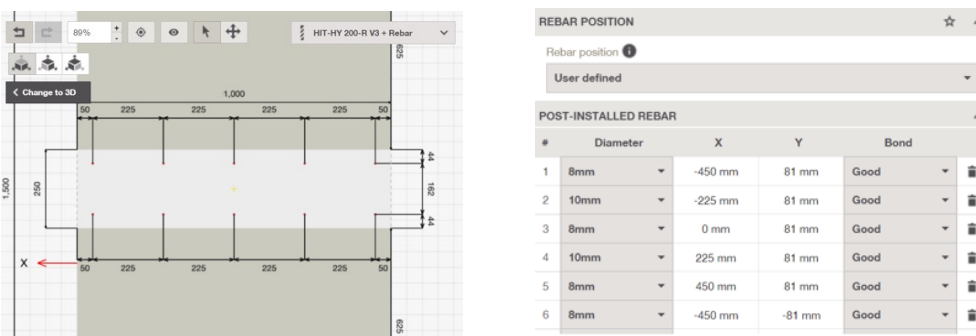

Fig. 8.9: User-defined rebar arrangement in PROFIS

**Shear design options:** Post-installed rebars are not generally designed to resist direct shear loading. Hence the interface between the existing and new concrete needs to be properly roughened to ensure the shear load is transferred by friction. As explained in sect. 7.1, various loading and shear reinforcement conditions (predominantly shear/bending with or without shear reinforcement) as per code provisions can be selected for the interface-shear capacity verification (see Fig. 8.10)

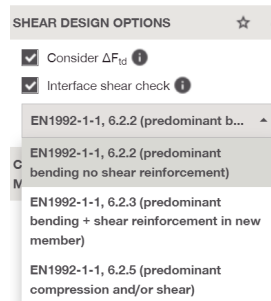

Fig. 8.10: Shear design of interface in PROFIS

**Single rebar module:** despite the wide variety of design methods and applications included in PROFIS, some specific applications that may occur in a project that needs a custom solution. Therefore, PROFIS offers the possibility to calculate the straightforward anchorage or lap length of a single bar taking into account the boundary conditions defined by the user and the loading on the bar (maybe derived from another program like Finite Element simulation or a different strut-and-tie model).

**Note:** The single rebar module in PROFIS can be quickly useful when designing for few rebars missing in the jobsite, rather than designing for the whole application.

**Settings menu:** PROFIS automatically calculates the maximum and minimum area of reinforcement as per the limitations of the code (e.g., EC2-1-1 [1]). However, PROFIS also allows the user to customize the min/max reinforcement limits. The settings menu allows to account for national regulated parameters in the European framework and any other framework preferred by the designer.



## 8.4 Designing shear-friction (overlay) applications using PROFIS

The following are the steps and features involved in designing post-installed shear connectors applications (shear-friction overlays) using PROFIS.

### Choosing application type

The shear-friction module in PROFIS allows the user to select predefined strengthening solutions for typical structural elements such as slabs, beams, and walls. In addition, the generic application provides simple and quick calculations for a generic shear-friction interface design (see Fig. 8.11).

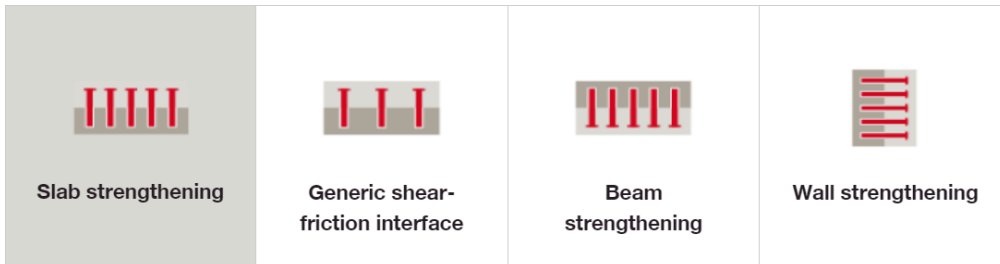

Fig. 8.11: Shear-friction overlay applications in PROFIS

### Concrete material properties and installation conditions

Similar to the possibilities discussed in section 8.3, the concrete material properties and installation conditions are to be defined for shear-friction (overlay) applications.

PROFIS gives the option of dividing the longitudinal length of the concrete members into discrete zones of user-defined segments (see Fig. 8.12). This segmentation agrees with the EOTA TR 066 [4] design method of zonal division to cater for different shear stresses at the edge (arising due to perimeter restraints) compared to stresses in the internal span/segments. This zonal discretization leads to efficient and economical design of the shear connectors.

**Note:** Surface roughness treatment of existing concrete is a user-defined option in PROFIS. Proper surface preparation is important for design of shear-friction (overlay) solutions.

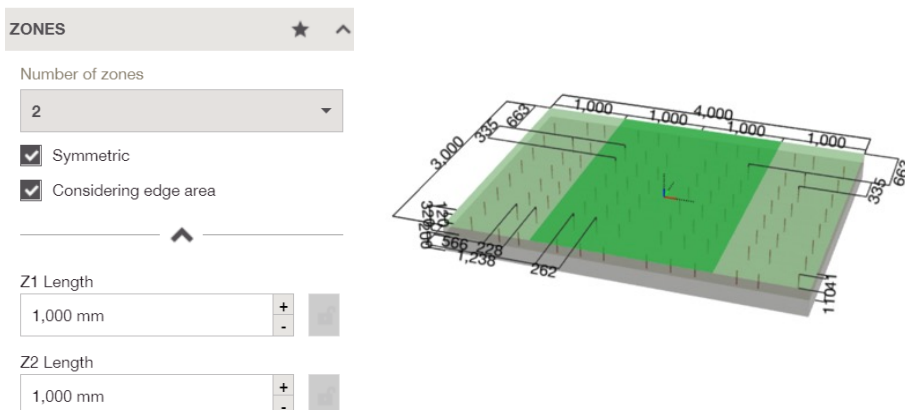

Fig. 8.12: Zone discretization of overlay panel

### Post-installed shear connector properties

All qualified products for shear connectors (mechanical, e.g., HUS4-H and chemical, e.g., HIT-RE 500 V4 + HCC-B, etc.) are available in PROFIS for choosing per the design intent and installation criteria (see Fig. 8.13). Hooked rebar can also be designed using the Hilti Method as discussed in [chapter 7](#).







<p>Hole diameter</p> <p>Min <input type="text"/> Max <input type="text"/></p> <p>Anchor type</p> <p><input checked="" type="checkbox"/> Mechanical</p> <p><input checked="" type="checkbox"/> Adhesive</p> <p>Corrosion / material</p> <p><input type="checkbox"/> Galvanized steel</p> <p><input type="checkbox"/> Stainless steel</p> <p><input type="checkbox"/> High corrosion resistant steel</p> <p>Cleaning</p> <p><input type="checkbox"/> SafeSet - no cleaning required</p> <p><input type="checkbox"/> SafeSet - automatic cleaning</p> <p><input type="checkbox"/> Manual cleaning</p> <p><input type="checkbox"/> Compressed air cleaning</p>		<p><b>HIT-RE 500 V4 + HCC-B</b></p> <p>HIT-RE 500 V4 injection mortar with HCC-B connector</p>
		<p><b>HIT-HY 200-R V3 + HCC-K</b></p> <p>HIT-HY 200-R V3 injection mortar with HCC-K connector</p>
		<p><b>HIT-RE 500 V4 + HCC-K</b></p> <p>HIT-RE 500 V4 injection mortar with HCC-K connector</p>
		<p><b>HUS4-H</b></p> <p>HUS screw anchor</p>
		<p><b>HUS3-H</b></p> <p>HUS screw anchor</p>
		<p><b>HIT-HY 200-R V3 + HAS-U</b></p> <p>HIT-HY 200-R V3 injection mortar with HAS-U threaded rod</p>

Fig. 8.13: Approved & qualified shear connector product solutions

### Design optimization of shear connectors

The design of the interface can be carried out according to the same principles explained in sect. 8.3, as "automatic" or "user-defined". Design optimization of shear connectors can be performed either by fixing:

- a) **The minimum number of shear connectors** (anchors) or
- b) **The minimum required embedment depth of the shear connectors** in the existing layer of concrete.

### Defining loads, load types & design standards

Design shear forces or stresses in the discretized zones can be entered in the loading table below the 3D Model. Load types (static, seismic, and fatigue) and the design standard (EOTA TR 066 [4] or Hilti method) can also be chosen by the designer. PROFIS displays the utilization ratios for shear interface verification and the tensile resistances for the various failure modes of the post-installed shear connectors as well.

Design shear stress acting parallel to the interface between new and existing concrete is the default input load option. Vertical shear force load input perpendicular to the interface is also possible in PROFIS. Shear forces are converted into shear stresses as specified by EOTA TR 066 [4]. (see Fig. 8.14). Also, any stress acting perpendicular to the interface (only compression) can also be defined by the user.

**STRESS** ☆ ^

Stress perpendicular to the interface

+ -

**LOADING DEFINITION** ☆ ^

Loading input type

Shear stress parallel to the interface

Shear force perpendicular to the interface

Fig. 8.14: Defining shear stress & shear force

### Design output (report & drawings)

In line with to the aspects mentioned in section 8.3, a comprehensive design output report can be generated at a click of a button in PROFIS.

## 9. INSTALLATION AND INSPECTION

The right installation procedure for post-installed systems in construction is important for the following reasons:

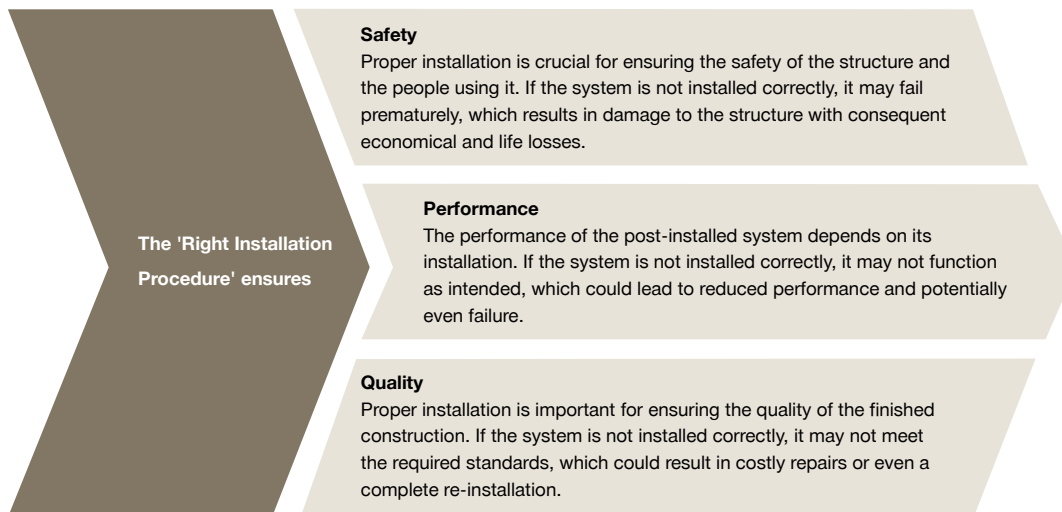

It is recommended that the installation is carried out by trained installers who have the necessary skills, knowledge, and experience to install the system properly. Additionally, it is important to follow the manufacturer's installation instructions and guidelines carefully. These instructions provide specific details on how the product shall be installed and include any special considerations or requirements that must be taken into account. Usage of qualified products is necessary since they have been tested and certified to meet certain standards and they are deemed suitable for use in specific applications. Refer to chapter 3 for product assessments and qualifications, and chapter 4 for qualified products from Hilti.

### 9.1 Post-installed rebar installation procedure

Post-installed rebar installation procedure involves the following steps:

#### 9.1.1 Post-installed rebar positioning

The first step is locating and fixing the positions of rebar, where drilling operations are planned. This requires scanning of base material to be free of existing reinforcement, pipes, tubes, cavities, etc. In the specific case of lap splices with post-installed rebars, the relative position to the lapping cast-in bars shall be carefully assessed.

**Note:** Hilti offers professional detection equipment to facilitate the installation of post-installed reinforcing bars.

The location of existing reinforcement and other embedded items is generally identified with scanning methods categorized as:

a) Scanners that locate ferrous materials using **Electro-Magnetic Induction (EMI) technology** like Hilti's PS 300 (see Fig. 9.1a,b). For reinforcing bars located within 200 mm of the concrete surface, ferrous scanners using EMI technology can detect rebar location and can also estimate both rebar cover and diameter.

b) Scanners that utilize **Pulse Radar Technology (PRT)** to detect both ferrous and non-ferrous embedded items like metals, post-tensioned system, non-metals like wood, wires, etc. and cavities. Example: Hilti's PS 85 and PS 1000. PRT type scanners like Hilti's PS 1000 (see Fig. 9.1c,d) can also be used for areas of heavy congestion or where existing reinforcing is too deep and in multiple layers.

**Note:** Hilti scanning equipment can also be used to estimate rebar cover, diameter and spacing (multiple layers) for structural identification and verification especially when as-built drawings are not available. Where available, it is preferable to supplement as-built or original design documents with scanning results.



a) Scanning for ferrous objects



b) HILTI's PS 300 Ferrosan

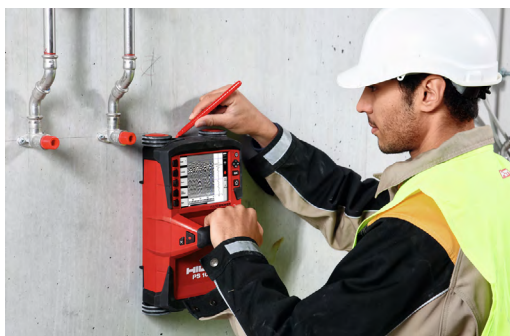

c) Scanning for ferrous &amp; non-ferrous objects



d) HILTI's PS 1000 with tablet

Fig. 9.1: Ferrous and non-ferrous scanning equipment for structural verification and documentation

### 9.1.2 Surface preparation/roughening

Before installing rebar, it is important to properly prepare the surface of the concrete. This may also involve repairing any cracks or defects in the surface of the concrete, roughening and cleaning the surface using appropriate tools and equipment and marking out the location of the rebar to ensure a precise drilling operation.

Surface roughening prior to casting new concrete against existing concrete provides not only increased adhesion, but also the ability of the joint to transfer shear through friction. Where new concrete is to be applied to an existing concrete surface, roughening should be prepared according to the intended use according to EC2-1-1 [1]. The surface should be with at least 3 mm roughness from to peak to valley at about 40 mm spacing (refer Fig. 9.2)

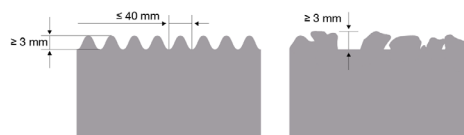
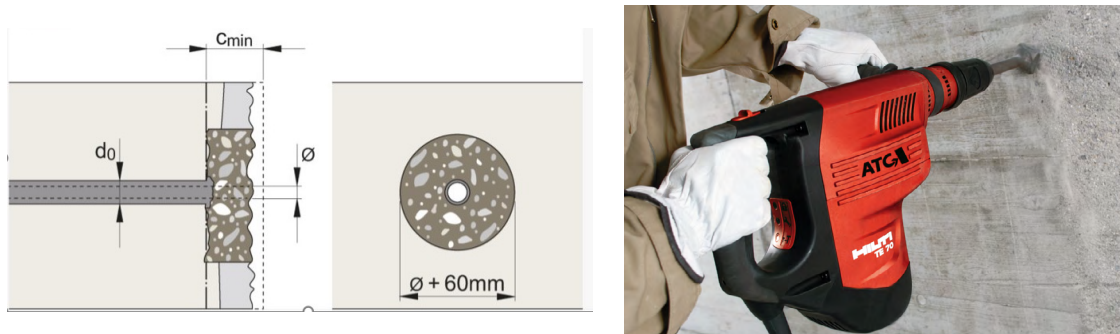

Fig. 9.2: Surface roughness requirement

When the surface layer of the existing concrete is carbonated, the carbonated layer should be removed in areas where post-installed reinforcing bars are to be installed. A rule of thumb is to remove the carbonated concrete over a circular area with a diameter given by the diameter of the bar plus 60mm ( $d_{\text{rough}} = \Phi + 60\text{mm}$ ), (see Fig. 9.3a). The required roughening may be accomplished by mechanical means (e.g., using Hilti TE 70-ATC equipped with a brushing tool, (see Fig. 9.3b), sandblasting or water-blasting.

**Note:** After roughening it must be ensured that the surface is free of dust or loose material prior to placing the new concrete.



a) Non-carbonated concrete zone

b) Surface roughening using brushing tool

Fig. 9.3: Existing concrete surface roughening requirement

### 9.1.3 Drilling of holes in concrete

Post-installed reinforcing bars typically require deep embedment. Correct hole drilling and cleaning are critical for their performance. Bore-holes are drilled using one of the following three methods, each having advantages and limitations:

- 1) **Rotary-impact drilling/hammer drilling (HD)** equipped with standard 2-flute helix (e.g., Hilti TE-C bits family) or cruciform carbide bits (e.g., Hilti TE-CX and TE-CYX families) for hammer drills (see Fig. 9.4) are readily available and are the preferred approach for most applications given their portability and ease of use. Hilti hammer drills produce a non-uniform hole surface especially suitable for ensuring proper bond (provided correct hole cleaning procedures are used). For deep and large diameter holes, hammer drills may not be practical. They are also not suitable for drilling through existing reinforcing where this is required.



Fig. 9.4: Hammer drilling (HD) tools

**Note:** Different types of drilling machines are available on the market. They are differentiated mainly by weight, impact energy, rotation and hammering frequency. Hilti recommends the most appropriate machine for different ranges of hole diameters to optimize productivity.

- 2) **Compressed air drilling (CA)** - compressed air drilling offers speed and efficiency and produces a rough drilled hole surface. The larger impact energy associated with compressed air may increase the tendency for damage in the concrete member, particularly if used in applications with small edge distance or reduced cover. (refer Fig. 5.5).



3) **Diamond core drilling (DD)** utilizes either wet or dry coring technology. For longer anchorage lengths and large diameters, core drills may be the preferred option (Fig. 9.5). In contrast to hammer drills, which fracture the concrete with impact energy, core drill bits utilize a sacrificial matrix containing diamond fragments to abrade the concrete. The stiffness of the core barrel permits holes to be drilled with less deviation from the intended path, and they are capable of drilling through existing reinforcing without great effort. Core drills typically produce a very smooth hole that is usually covered with a thin film of dust that is deleterious to bonding. For qualified systems, specific hole cleaning procedures have been developed and are included in the product ETAs and in the Instruction for Use (IFU).

**Note:** Diamond coring is preferable where vibration, noise and/or dust production should be minimized.

**Note:** Drilling through existing reinforcing or other embedded objects should in general not be undertaken prior to consultation with the engineer of record or other authority having jurisdiction.



a) Diamond core drilling (Hilti DD 30-W)



b) Diamond core drilling (Hilti DD 250 CA)

Fig. 9.5: Diamond core drilling tools

The Fig. 9.6 shows the influence of the various drilling techniques on the load-displacement behavior of post-installed reinforcing bar with a mortar. It is evident from the figure that the adhesive mortar tested is not approved for diamond drilling since the bond strength is dramatically lower than for hammer or compressed air drilling.

**Note:** Check the suitability & bond strength of qualified adhesive mortars for use with core drilled holes.

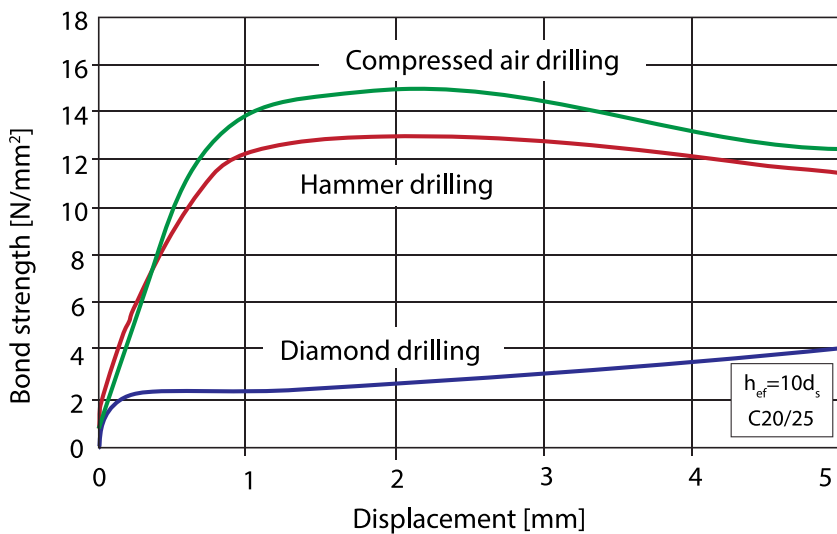

Fig. 9.6: Influence of drilling method on the bond-displacement behavior of a post-installed rebar with embedment of  $10\phi$  in low-strength concrete and cleaned hole [5]



Fig. 9.7: Example of drilling aid

**Using drilling aid:** during the drilling operation, a sufficient distance must be provided from the existing concrete edge to avoid splitting and/or spalling of the cover. Drilling alignment aids can be employed with hand-held drilling machines to improve drilling accuracy (see Fig. 9.7). Detailed rules related to minimum concrete cover in case of drilling aid usage are mentioned in section 5.2.1.

#### 9.1.4 Roughening of drilled (bore) holes

To overcome the unsuitability of certain mortars with the smooth interior surfaces of drilled holes which are produced with the diamond coring technique, Hilti has developed a roughening tool. The TE-Y RT “Flex fork” tool (see Fig. 9.8) helps in roughening the smooth surfaces of such holes allowing increased mechanical interlock between mortar and concrete (see Fig. 9.8b). This results in achieving the intended bond strength.



a) Roughening tool bit “Flex Fork” TE-Y RT



b) Difference between roughened & smooth borehole in concrete

Fig. 9.8: Importance of roughening of boreholes in concrete

#### 9.1.5 Cleaning of drilled holes

The bond between adhesive and concrete is directly influenced by the condition of the drilled hole wall at the time of adhesive injection. The concrete in which the post-installed reinforcing bar is to be installed may be dry, saturated or even partially or completely submerged at the time of installation.

Installation shall be done according to the IFU. Wet diamond core drilling will result in a damp environment in the drilled hole. Diamond cored-hole cleaning generally involves sequential flushing until clear water exits, blowing out of the hole with compressed air tool and accessories (Fig. 9.9 & Fig. 9.10). Then a wire brush is used mechanically to roughen the hole wall. All cleaning procedures end with the use of compressed air and hence IFU & ETA shall be followed for safe and correct installation.

**Note:** Installation in water-filled boreholes requires qualified adhesive system for this condition.

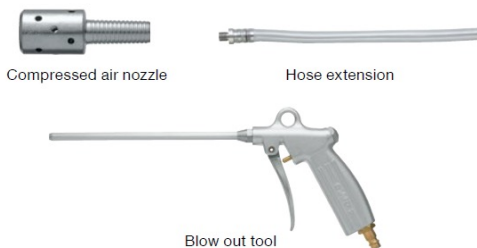

Fig. 9.9: Compressed air tool and accessories for blow-out cleaning of holes



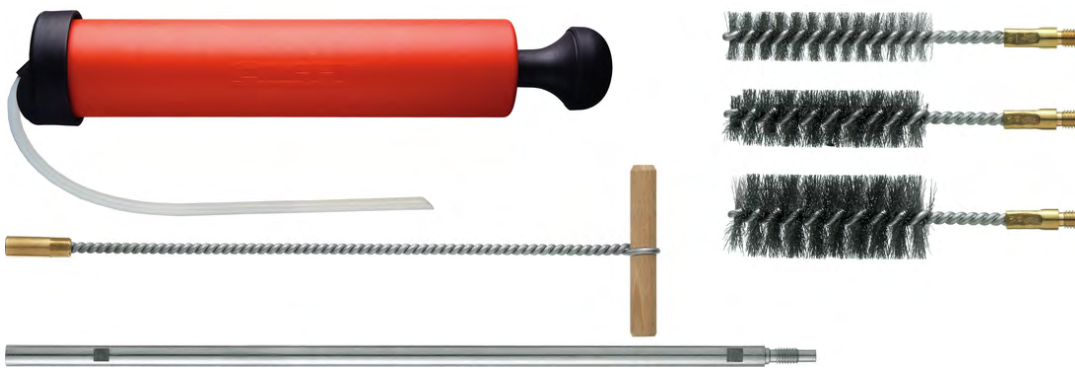
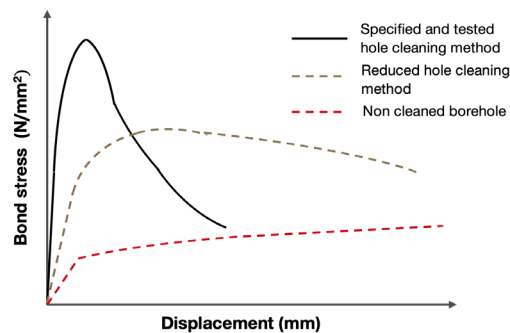

Fig. 9.10: Hole cleaning wire-brush and accessories for cleaning of holes

**Note:** The importance of hole cleaning methods as specified in the Hilti IFU for ensuring the performance of post-installed reinforcing bars is indicated in Fig. 9.11. To overcome the need of adherence to multi-step hole cleaning procedures, use of Hilti SafeSet™ technology is recommended (see Section 9.1.7).



a) Air blow-out of dust from boreholes



b) Influence of cleaning methods on bond stress Vs displacement

Fig. 9.11: Removal of dust from boreholes and importance of hole cleaning

### 9.1.6 Injection of adhesive mortar and rebar installation

The objective of adhesive injection is to achieve a void-free installation. Air voids reduce bond area and consequently the load-carrying capacity of a post-installed rebar. Air voids can be detected from increased effort associated with rebar insertion in the bore hole and/or uncontrolled ejection of the adhesive from the hole as the air is forced out of the adhesive matrix. In order to inject the adhesive with minimal air voids in drilled holes, Hilti recommends the use of matched-tolerance piston plugs (see Fig. 9.12). Piston plugs provide positive feedback to the operator for controlling the injection process through the pressure of the adhesive on the plug and has been shown to dramatically improve injection quality and efficiency by eliminating air voids.

**Note:** Proper skin and eye protection as per IFU should always be worn during the injection of Hilti adhesives.

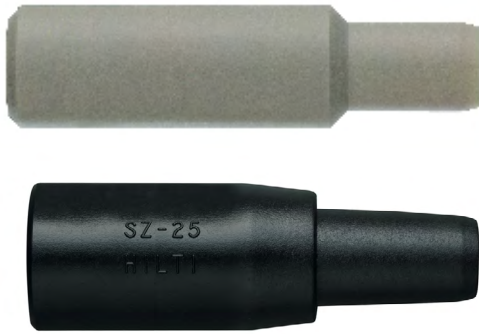

a) Piston plugs



b) Extension hose for adhesive mortar injection

Fig. 9.12: Proper injection of adhesive using piston plugs and extension hole

Dispensing equipment used for injection is generally selected as a function of rebar size, orientation, ambient temperature conditions and accessibility. Hilti offers manual, battery powered and pneumatic adhesive dispensers (see Fig. 9.13). Recommendations regarding the sizing of the dispenser for specific applications are provided in the IFUs and ETAs of Hilti post-installed rebar systems.

**Note:** Pneumatic dispensers are preferable in cases of large diameter & embedment lengths of rebars.



a) Manual, battery powered &amp; pneumatic dispensers



b) HILTI HDE 500-A22 automatic dispenser with extension hose

Fig. 9.13: Dispensing of adhesive mortar

**Note:** Simple checks can be used to assess the quality of the adhesive mortar injection. Spring-back movements of the bar during insertion produced by encapsulated air voids or the noise due to their shifting towards the concrete surface indicate the presence of significant air voids in the drilled hole. In such cases it is recommended to repeat the installation. Furthermore, it must be ensured that the mortar reaches the concrete surface after the insertion of the reinforcing bar. Thus, the importance of use of a piston-plug for adhesive mortar injection is clearly evident as in Fig. 9.14.

Smaller diameter rebars can be inserted in a vertically downward direction with (relatively) small effort. However, larger diameter rebars in horizontal and upward-inclined orientations may require substantial effort to lift and to be inserted into the adhesive-filled hole (see Fig. 9.15). In all cases, after drilling the hole diameter (as per ETA), it is advisable to test the fit of the rebar in the hole prior to injecting the adhesive mortar. For overhead installations, particularly of larger diameter rebars, provision must be made for securing the bar during adhesive curing. In addition, certification requirements may apply for installers performing installation of rebars to carry sustained tension loads, as well as special inspection requirements.

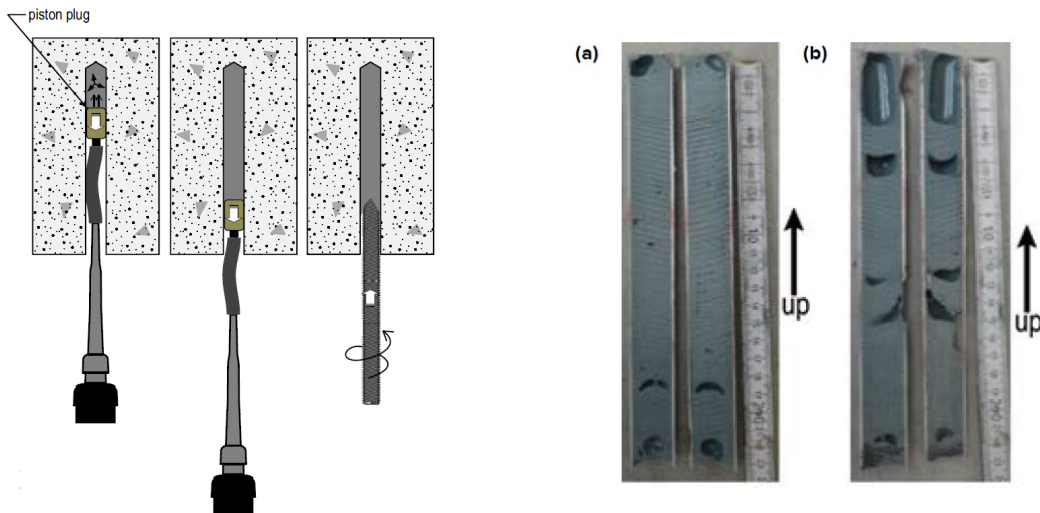

Fig. 9.14: (I) Usage of piston plug for adhesive injection (II) Images showing (a) successful injection of adhesive ( $\leq 10\%$  voids) using piston plug & (b) failed injection of adhesive ( $>10\%$  voids) [49]

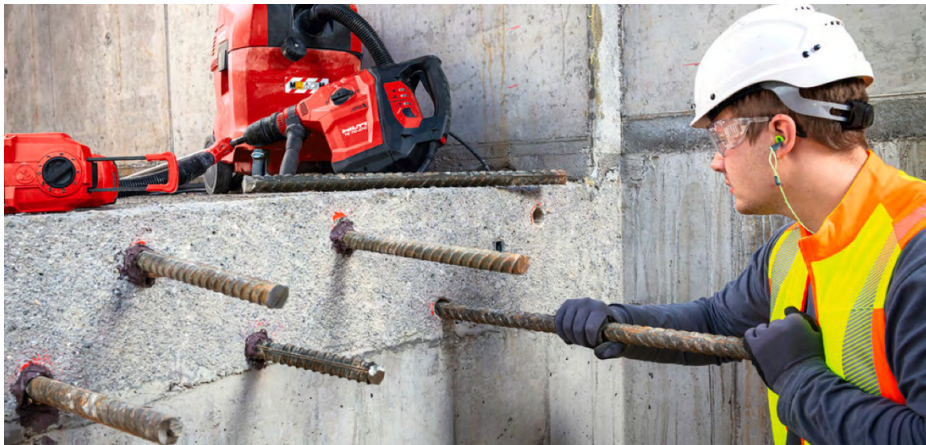

Fig. 9.15: Horizontal installation of large diameter type post-installed rebars

### 9.1.7 Hilti SafeSet™ system

The Hilti SafeSet™ system addresses the key steps of installation workflow of post-installed rebars in an efficient and safe way. This system includes qualified products and tools to easily achieve clean drilled holes and mortar injection with minimized waste production for easier and safer installation.

1. **Dust-free drilling process:** Hollow Drill Bits (HDB) used in combination with Hilti Vacuum Cleaners (VC 40-U or VC 20-U) (see Fig. 9.16) utilize state-of-the-art drilling technology to achieve clean drilled holes. The Hilti SafeSet™ system performs equally well in dry and wet concrete and eliminates the most critical and time-consuming step in the installation process, which is cleaning the hole before injection of the adhesive. The dust and debris produced is continuously sucked into the vacuum cleaners during the entire drilling operation, following the IFU for installation quality and safety for both health and environment.



Note: Hilti SafeSet™ supports proper execution of post-installed rebars, even in most complex job sites.





Fig. 9.16: Hilti SafeSet™ system – dust-free drilling of holes with hollow drill bits (HDB)

- 2) **Smart injection of adhesive mortar** in drilled holes is achieved using the Hilti HDE 500-A22 battery powered dispenser that is paired with a mobile application for calculating the required mortar volume (dosing). The calculated volume can be preset in the dispenser before injecting in the drilled holes (see Fig. 9.17). The user will be guided to have the exact amount of mortar thus eliminating underfilling which compromises quality, or overfilling that causes material wastage.



a) HDE 500-A22 automatic dispenser with extension hose



b) Hilti volume calculation application

Fig. 9.17: Smart Injection of adhesive mortar

**Note:** Hilti SafeSet™ system offers:

**Fast** – Drilling of bore-holes and cleaning of dust is made faster due to automated vacuum cleaning, smart dosing of adhesive, thus allowing fewer and faster installation steps.

**Simple** – Our systems allow the most intuitive and straightforward installation of rebars, reducing the risk of errors.

**Safe** – Approved SafeSet™ system helps ensuring proper installation of rebars, even in complex jobsites, to fulfill the design specifications.

## 9.2 Post-Installed shear connectors installation procedure

The installation of post-installed shear connectors follows the same procedure mentioned in section 9.1, where post-installed rebars are used as dowels. However here, instead of rebars, qualified shear connectors (e.g., HUS4-H or HCC-B) are installed as per manufacturer's IFU and then the new overlay concrete is poured as per the specifications given by the Engineer of Record (EoR)

The execution of concrete overlays involves the following overall processes (see Fig. 9.18):

- 1) Demolition or exposure of the existing concrete member or damaged concrete member layer
- 2) Proper roughening of the exposed concrete surface
- 3) Installation of the post-installed shear connectors (rebars/studs)
- 4) Laying and placement of the new required reinforcement layers
- 5) Final placement of the new concrete overlay of the required thickness

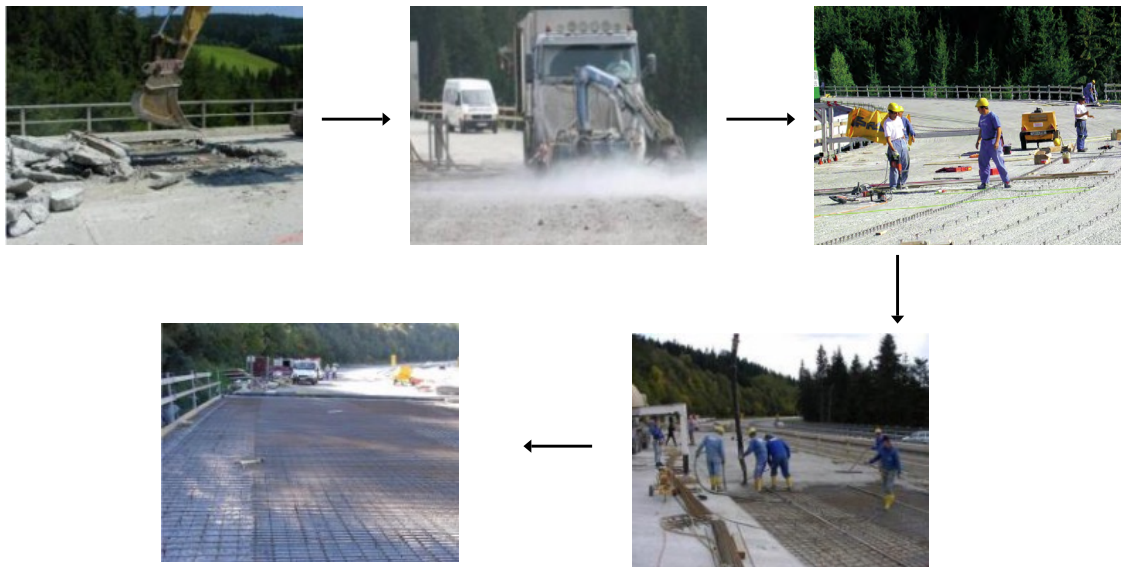

Fig. 9.18: Construction sequence of shear-friction overlay slab application (images in clockwise order)

### 9.2.1 Construction requirements for post-installed shear connectors as per EOTA TR 066

In addition to the reinforcement detailing and construction requirements for post-installed shear connection systems as mentioned in [chapter 7](#), the following main requirements shall be fulfilled for an existing concrete layer:

- Surface roughness should be achieved as per Table 7.5 and Table 7.6 and the concrete grain texture must be visible. The roughness can be measured by suitable methods, e.g., according to EN 13036-1 [50] or optical measurements.
- The surface roughness measurement and bond strength test should occur at least once per every 100 m<sup>2</sup> of surface area, with a minimum of 5 such evaluations or as per the requirement of inspection authority.
- The surface should be free from any oil, dust and dirt. Drill holes shall be cleaned free of oil using compression air and shear connectors shall be cleaned as per IFU.
- The existing concrete surface should be saturated and kept moist without free-standing water while the new concrete layer is being poured.

The new concrete of the overlay portion shall satisfy the following construction requirements:

- The compressive strength of the new concrete should be higher than that of the existing concrete.
- The new concrete should have low shrinkage properties.
- The new concrete should be consolidated with vibratory screed. If the new overlay thickness is more than 100 mm, appropriate internal vibratory needles are recommended.
- Post-pour checks and treatment of new concrete layer shall be carried as per applicable specifications and code requirements.

Additional requirements listed in the EOTA TR 066 [4] or applicable local regulations shall be followed (e.g., RVS 15.02.34 [51]).

## 9.3 Inspection, testing & quality control

Inspection, testing, and quality control are of key importance in the construction and installation of post-installed systems because they help ensure that the project work meets its requirements and specification. They can include verifying the materials and products through laboratory tests against the performance criteria, conducting on-site tests such as pull tests of post-installed rebars/shear connectors (see Fig. 9.19).

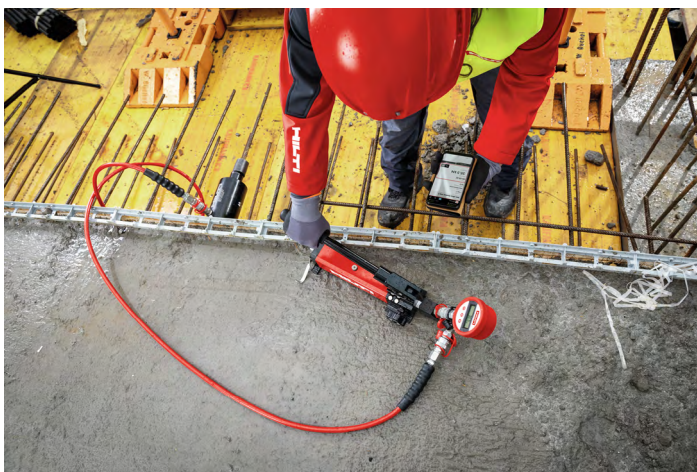

Fig. 9.19: On-site testing services offered by Hilti

On-site testing can be employed for the following two purposes:

- **Proof-load check:** Relevant to assess the load-displacement behaviour of post-installed rebars have been installed correctly. It is important to note that correct installation is usually achieved only when IFU are followed by trained and skilled installers. On-site proof loading is only a means to check and validate the quality of installation.
- **Missing design values:** Onsite testing can help the designer/engineer in arriving at design value of post-installed rebar system, through engineering judgement, when a standard design method/solution is not available. This can be particularly useful for projects involving retrofitting/strengthening applications.

**Note:** On-site testing should not be employed to assess bond resistances higher than the values included in an ETA for conditions covered by the same ETA (e.g., a post-installed rebar in normal concrete within the classes C12/15 and C50/60). The assessment of bond strengths for conditions beyond the scope of an ETA should account for influencing factors that could not be tested (e.g., elevated temperature or sustained load).

Contact Hilti for support with engineering judgements for non-standard cases of design resistances in unknown base material conditions.

Quality control involves actively managing the construction process and implementing corrective actions when necessary. Given in the next page is a quality control checklist of recommended activities that can be used for post-installed rebar and shear connector installation.

**Note:** The items mentioned in the following checklist are not exhaustive and not project-specific, hence it is the responsibility of the project team to amend as necessary before using it.



Work items to be checked for post-installed systems		Value(s)	Check		
			Yes	No	N.A.
<b>A1.</b>	<b>Drawing, specification &amp; method statement checks</b>		<input type="checkbox"/>	<input type="checkbox"/>	<input type="checkbox"/>
<b>A2.</b>	<b>Pre-installation checks</b>				
A2.1	Existing Member level		<input type="checkbox"/>	<input type="checkbox"/>	<input type="checkbox"/>
A2.2	Post-installed bar location / level		<input type="checkbox"/>	<input type="checkbox"/>	<input type="checkbox"/>
A2.3	Scanning of base material for existing rebar/other objects		<input type="checkbox"/>	<input type="checkbox"/>	<input type="checkbox"/>
A2.4	Concrete surface preparation checked as per IFU		<input type="checkbox"/>	<input type="checkbox"/>	<input type="checkbox"/>
A2.5	Drilling technique checked as per IFU		<input type="checkbox"/>	<input type="checkbox"/>	<input type="checkbox"/>
A2.6	<b>Hilti SafeSet™ system employed</b>		<input type="checkbox"/>	<input type="checkbox"/>	<input type="checkbox"/>
A2.7	Drilling depth and diameter		<input type="checkbox"/>	<input type="checkbox"/>	<input type="checkbox"/>
A2.8	Bore-hole roughening and cleaning as per IFU		<input type="checkbox"/>	<input type="checkbox"/>	<input type="checkbox"/>
<b>A3.</b>	<b>Adhesive mortar check</b>				
A3.1	Approved adhesive mortar used		<input type="checkbox"/>	<input type="checkbox"/>	<input type="checkbox"/>
A3.2	Adhesive mortar batch sheet & test reports		<input type="checkbox"/>	<input type="checkbox"/>	<input type="checkbox"/>
A3.3	Temperature and surface condition before injection		<input type="checkbox"/>	<input type="checkbox"/>	<input type="checkbox"/>
A3.4	Tools and accessories for mortar dispense as per IFU		<input type="checkbox"/>	<input type="checkbox"/>	<input type="checkbox"/>
A3.5	<b>Hilti SafeSet™ system used for smart injection</b>		<input type="checkbox"/>	<input type="checkbox"/>	<input type="checkbox"/>
A3.6	Required volume of mortar (Hilti volume calculator app)		<input type="checkbox"/>	<input type="checkbox"/>	<input type="checkbox"/>
<b>A4.</b>	<b>Post-installed rebar/shear connector checks</b>				
A4.1	Rebar/shear connector diameter and size as per specification		<input type="checkbox"/>	<input type="checkbox"/>	<input type="checkbox"/>
A4.2	Rebar/shear connector inserted as per IFU		<input type="checkbox"/>	<input type="checkbox"/>	<input type="checkbox"/>
A4.3	Embedment depth and perpendicularity of rebars check		<input type="checkbox"/>	<input type="checkbox"/>	<input type="checkbox"/>
A4.4	Provision for rebar holding (overhead/inclined) check		<input type="checkbox"/>	<input type="checkbox"/>	<input type="checkbox"/>
A4.5	Mortar curing time check		<input type="checkbox"/>	<input type="checkbox"/>	<input type="checkbox"/>
A4.6	On-site pullout test conducted		<input type="checkbox"/>	<input type="checkbox"/>	<input type="checkbox"/>
<b>A5.</b>	<b>New concrete rebar checks as per project specifications</b>		<input type="checkbox"/>	<input type="checkbox"/>	<input type="checkbox"/>
<b>Note: Formwork, concreting, health, safety, environment, and all other checks as per the project scope</b>					

## 9.4 Additional construction/installation aspects

### 9.4.1 Concrete sensors for on-site monitoring

Concrete strength and temperature monitoring are important aspects of construction projects. They help in ensuring that the concrete is properly cured and is of sufficient strength for the intended use. The conventional method for determining the strength at specific intervals is to use concrete test cubes or cylinders. Temperature monitoring can be done using temperature probes, which are placed within the concrete during the pouring process. The probes track the temperature of the concrete as it cures. Hilti's wireless **Concrete Sensors (HCS)** can help benefit the key stakeholders of a construction project in taking timely critical decisions involving the following advantages:



Fig.9.20: Hilti concrete sensor (wireless) that transmits real-time data on concrete temperature, strength and relative humidity onto the concrete sensors mobile application

**Note:** Data reported via Hilti concrete sensors, requires project stakeholders' discretion to make decisions.

- 1) **Concrete strength evaluation** works on the concept of concrete "maturity" which is a non-destructive and reliable technique used for more accurate estimate of the effects of time and temperature on concrete strength development. The data is transferred wirelessly by Bluetooth technology to a mobile application, from the sensor which is embedded inside the structural element before the concrete is poured (see Fig. 9.20). Hilti concrete sensors perform the 'Equivalent Age test' at four different temperatures to increase accuracy while calibrating the sensors for each unique mix design of concrete. The real-time data from the wireless sensors help the project team in deciding earlier removal or formwork, earlier construction loading on structural elements, loading of post-installed rebars, etc.
- 2) **Monitoring the in-situ temperature of concrete in real-time** can be done by Hilti concrete sensors. Monitoring internal concrete curing temperature and temperature differentials between multiple points within the concrete, can help to ensure compliance with building code, specifications, and thermal control plans. Thermal control plans are necessary to manage proper curing in such a way that the maximum internal temperature and the temperature differentials from center to surface are not exceeded beyond specified limits. This control is crucial for mass concreting operations for cooling the interior of the concrete while warming the exterior of the concrete (e.g., raft construction and thick concrete overlays).

**Note:** Hilti concrete sensor real-time temperature data can be a part of concrete reports /alerts for making project decisions.

**Note:** Contact Hilti for more information on services offered through the Hilti concrete sensor system (if available in your market region) that includes the sensors, mobile application, gateway for wireless data transmission, Hilti database and Hilti laboratory services (see Fig. 9.21).

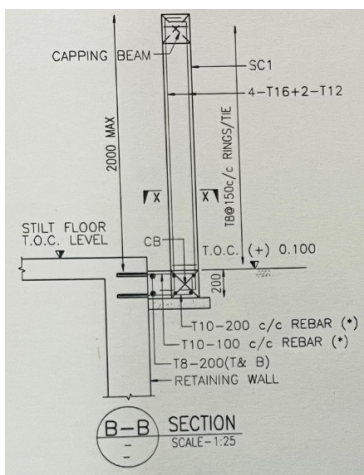

Fig. 9.21: Hilti concrete sensor system solution

## 9.5 Construction specifications

A specification can be rolled out by the engineers/designers for a complete and reliable implementation of applications, which have been designed by qualified products with installation guidelines (see example in Fig. 9.22). A construction specification should address the following:

- Post-installed rebar details along with installation depth and qualified product(s)
- Clear design requirements such as product performance (design life, loading type, etc.) and applicable design method (e.g., EC2, EOTA TR 069 [2])
- Description of preparation works (e.g., scanning of base material, drilling method, etc.)
- Description of installation requirements (tools, accessories such as piston plug, extension hose, Hilti SafeSet™ system, etc.)
- Additional requirements (e.g., on-site testing if required)



NOTES FOR RE BARRING :-	
1.	SCANNING & MARKING OF THE EXISTING REINFORCEMENT WITH HILTI PS300 SCANNING TOOL TO AVOID THE HITTING OF THE EXISTING REBARS AND PUNCTURING THE EXISTING CONCRETE.
2.	INSTALLATION METHODOLOGY SHALL BE AS PER REBARRING DESIGN REPORT USING HOLLOW DRILL BIT TECHNOLOGY TO ENSURE DUST-FREE CLEAN HOLES AND PROPER BONDING OF CHEMICAL.
3.	HILTI CHEMICAL & EMBEDMENT DEPTH TO BE FOLLOWED FOR REBARRING AS PER DETAILS IN THE DRAWING/ APPROVED DESIGN.
4.	REBARRING SHALL BE DESIGNED AS PER EC2 TR023/ HIT REBAR METHOD/TR 069 BEFORE EXECUTION CONSIDERING REBARS GROUP BEHAVIOUR
5.	CHEMICAL SHALL BE ETA SEISMIC APPROVED AND 100 YEARS' SERVICE LIFE FOR REBARRING
6.	PISTON PLUG & EXTENSION PIPE SHALL BE USED FOR HOLE DEPTH GREATER THAN 400 MM TO ENSURE PROPER FILLING OF HOLES AND SAFE INSTALLATION
7.	PULL OUT TEST REPORT TO BE SUBMITTED TO THE STRUCTURAL CONSULTANT TO VERIFY THE QUALITY OF INSTALLATION.

\* NOTES:-  
 TOP 1: Ø 10 MM / 170 MM EMBEDMENT DEPTH // 100 MM SPACING WITH HILTI HIT-HY 200-R V3 INSTALLATION PER ETA 19/0600, HAMMER DRILLING, USING AN INJECTION PISTON PLUG  
 BOTTOM 1: Ø 10 MM / 109 MM EMBEDMENT DEPTH // 200 MM SPACING WITH HILTI HIT-HY 200-R V3 INSTALLATION PER ETA 19/0600, HAMMER DRILLING, USING AN INJECTION PISTON PLUG

Fig. 9.22: A reference specification for a complete and reliable solution

## 9.6 Hilti for engineering support

Engineering judgement is essential for ensuring reliable and efficient design, especially when standard methods for solutions are not available. It requires a deep understanding of engineering principles, a broad knowledge of relevant solutions and techniques, and an ability to apply appropriate problem-solving skills in complex situations. Hilti offers the following options to designers to tackle such situations requiring sound engineering judgements:

### Ask Hilti

Ask Hilti is an online community offering collaborative environment and curated expert advice to construction engineers and architects. Ask Hilti is free and open to everyone. Registered users can post questions and participate in technical discussions.



### Hilti Backoffice

Hilti offers assistance in designing solutions for complex and non-typical problems & situations. You can reach out to Hilti for help from its back-end engineering support team, either through online or offline communication.

### Hilti Assets

Hilti has a collection of technical publications like whitepapers, handbooks, guidelines, training materials, etc. on relevant subject matters of interest for the engineering/design community. This caters to knowledge dissemination of the latest technology and practices.



## 10. REFERENCE PROJECTS

### 10.1 Nathani Heights, Mumbai, India

Nathani Heights is an iconic Residential Skyscraper which is 262m tall and located in one of the busiest locations of downtown Mumbai. Construction was completed in 2020.

#### Problem Statement & Objective

The requirement of adding additional floors to the existing skyscraper occurred after permission to increase the Floor Space Index (FSI) by the local government authority for further development. Also, the client decided to change the functionality of certain floors in the lower levels to cater to increased loads due to vehicle parking/movement usage. Hence the objective was to have optimized design of post-installed rebars for the cross-section enhancement of existing columns (jacketing application), shear friction overlay of existing slabs (slab thickening application), and easy installation of the same within the time constraints (see Fig. 10.1).

Design methods used:  
EOTA TR 069  
EC2-1-1  
Hilti method



a) Project rendering



b) Column jacketing



c) Slab strengthening

Fig. 10.1: Nathani Heights residential skyscraper

#### Approach followed (design & solution)

- Regular and dynamic meetings were conducted with the Engineering & Design team of the skyscraper to understand and emphasize compliant design methods to achieve efficiency, as well as Hilti qualified products that suited the design and site requirements, and documentation.
- Gaps in design approaches and calculations were spotted. Together with the design team, current practices and methodology were used to find code compliant solutions.
- Consideration of correct value of sustained load factor  $\psi_{sus}$  calculated as per EOTA TR 069 [2] and relevant product ETA (Hilti's HIT-RE 500 has higher value of the factor, among others), helped the design team to arrive at efficient and optimized embedment depths.



## Design methods used

**Simply supported connections** – Hilti method was used to take advantage of increased bond strength

**Column strengthening** – EOTA TR 069 [2] design method was used for anchorage of longitudinal rebars

**Slab/Column strengthening** – EC2-1-1 design method was used for shear friction overlay application

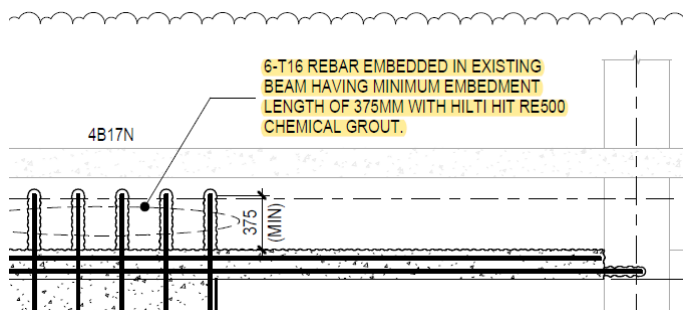

Fig. 10.2: Design drawing specification (Nathani heights)

Note: Hilti's PROFIS Engineering software was used for design productivity.

## Total solution & benefits

**Software:** PROFIS Engineering was used for design productivity by the designer.

**Hardware:** Hilti RE 500 was used to install rebars and accommodate build design. Cost reduction was possible due to optimized embedment depth (refer Fig. 10.2).

**Services:** Hilti has been in frequent touch points with the design team for assistance and to bring design efficiencies using design methods EOTA TR 069 [2], Hilti method and EC2-1-1 [1] code provisions. On-site pull-out tests were also conducted as adjunct to help the customer to validate the installation done by the project execution team with relevance to design proof loading.

**Training:** Hilti delivered training sessions for installation at jobsites.



## 10.2 School seismic strengthening, Bologna, Italy

Seismic strengthening of the junior high school “Marco Polo” in Crevalcore (Bologna, Italy), (see Fig. 10.3.)



a) Exterior View

a) Building after seismic intervention

Fig. 10.3: Junior high school “Marco Polo” in Crevalcore (Bologna, Italy) after the seismic intervention (strengthening)

### Problem statement and objective

The building was severely damaged during the 2012 Emilia Earthquake. The flexible, partially prefabricated structure was largely undamaged after the seismic event. However, non-structural components were seriously damaged. Therefore, it was decided to strengthen and stiffen the existing structure. The main seismic interventions consisted of stiffening the floors and the addition of shear-infill walls (see Fig. 10.4). The seismic intervention increased the seismic resistance of the building from 10% to 110% compared to the requirement for a comparable new school building according to latest codes & standards.

**Note:** The intervention (strengthening) increased the seismic resistance of the building from 10% to 110% as per applicable codes & standards

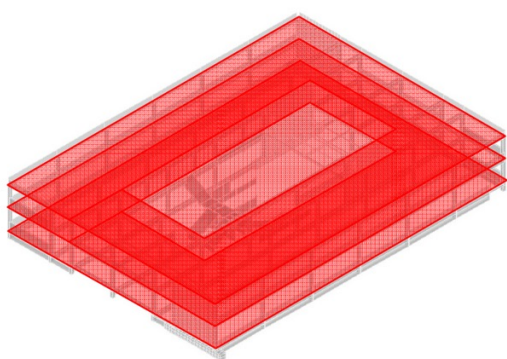

a) Schematic view of floors

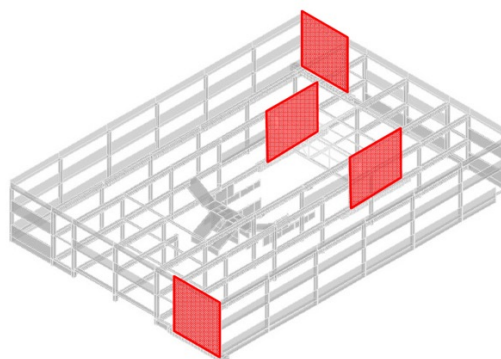

b) Location of new shear-infill walls

Fig. 10.4: Schematic view of stiffened floors and shear-infill walls

### Approach Followed (Design & Solution)

Post-installed rebars with HIT-RE 500 were used for the overlay on the floors as well as the connection with surrounding walls (Fig. 10.5) and the connection of the shear infill walls with the existing reinforced concrete frames (Fig. 10.6).

### The design methods used

EN 1992-1-1, EN 1998-1 and national regulations



a) Concrete overlay on existing floors

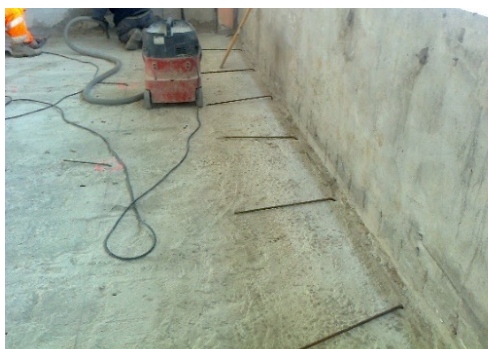

b) Connection of overlay to perimeter walls

Figure 10.5: Construction of concrete overlay



a) Corner walls



b) Interior walls

Fig. 10.6: Addition of new shear-infill-walls

### Total solution & benefits

**Hardware:** usage of mortar (Hilti RE 500) and installation tools (Hilti SafeSet™ System, drill bits, etc.)

**Software:** PROFIS Engineering was used for the design of the structural connections.

**Note:** Hilti SafeSet™ Technology was used for safe and hassle-free installation rebars.



### 10.3 The Exchange 106, Kuala Lumpur, Malaysia

The Exchange 106 is a luxury super-tall skyscraper with mixed use functions, which is 454 m in height and located in the business district TRX of Kuala Lumpur, Malaysia. The construction of the skyscraper was completed in 2019.

#### Problem statement & objective

Lift core walls are usually constructed using formwork technologies that reduce complications and speed up the work towards completion. The objective for the construction team was to have easier and faster structural connections of all the floor slabs to the lift core-walls of the building using post-installed rebars (see Fig. 10.7). Thus, the need for cast-in dowels projecting out from the core walls was averted.



a) External view



b) Post-installed rebars installation for slab to wall connection



c) On-site inspection of post-installed rebars installation

Fig. 10.7: The Exchange 106 (mixed-use skyscraper)

#### Approach followed (design & solution)

- Since more than 100 floor slabs had to be structurally connected to the core-walls using post-installed rebars, design optimization of embedment depth was crucial for the design and construction team to save on cost.
- Embedment depth of post-installed rebars was optimized using the Hilti Method to take advantage of the higher bond strength than the value limited by EC2-1-1 [1].
- Hilti's PROFIS Engineering software was used for optimized design and documentation of calculations.

Design methods used:

Hilti method

- Existing member cross-section verifications were carried out, including for fire exposure. The mortar selected (Hilti's HIT-RE 500) needed a third-party fire testing report as per the specifications and this was provided by Hilti for compliance.

### Design methods used

**Hilti method** – Optimized embedment depth for floor slabs to lift-core wall connections (see Fig. 10.8)

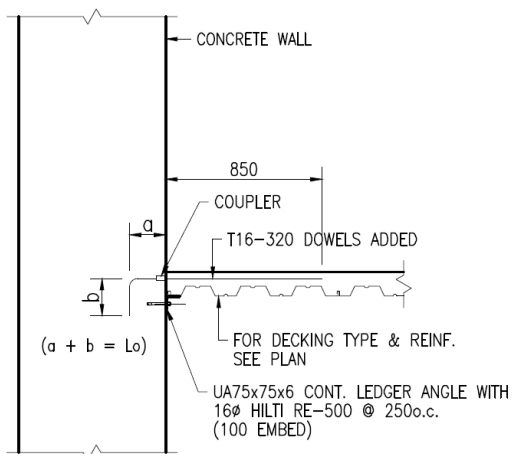

**NOTE:**

DETAILS SHOWS PARALLEL TO CONCRETE WALL CONDITION.  
DECK PERPENDICULAR TO WALL CONDITION IS SIMILAR.

Fig. 10.8: Design drawing detail with specifications (The Exchange 106)

### Total solution & benefits

**Software:** PROFIS Engineering was used for design productivity by the designer.

**Hardware:** HIT-RE 500, Hilti drilling tools and drill-bits.

**Services:** on-site testing as adjunct for the customer to validate quality of post-installed rebar installation.

**Benefits:** cost saving on embedment depth, easy and fast installation.

**Training:** Hilti also delivered training sessions for installation at jobsites.

## 10.4 Schott Solar Jena AXL 33, Germany

Slab strengthening (shear friction overlay) application at the industrial building of 'Schott Solar', located at Jena in Germany. This application was planned by 'HI Bauprojekt GmbH', Jena and the installation was completed in the year 2007.

### Problem statement & objective

The company Schott Solar in Jena planned to install new production facilities. These needed to carry heavy forklift traffic loading on the floor slabs in the 3-storey industrial building, which was built in the 1940s. The load-bearing capacity of the 16 cm thick ribbed-reinforced concrete slabs was not sufficient. Hence, the strengthening of the floor slabs was planned, designed and executed (see Fig. 10.9).

Note: Cost savings of  
~€700,000 for the client.



a) The 3 storey industrial building

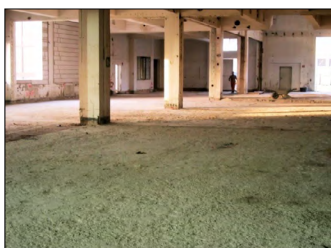

b) Roughened slab surface



c) Slab strengthening with HCC-K shear connectors

Fig. 10.9: Schott Solar industrial building, Jena, Germany

### Approach followed (design & solution)

- In cooperation with the responsible project manager and structural engineer, the Hilti team worked on the requirement for an efficient and fast solution since slab dismantling would have involved more cost and time.
- The 3500 m<sup>2</sup> slab area was reinforced with Hilti's HCC-K shear connectors.
- Hilti drill bits were used for faster preparation of bore holes.
- HIT-RE 500 adhesive mortar was used for safely securing the shear connectors on the existing floor slabs.
- This turned out to be the most economical solution since the floor slabs were not dismantled and then rebuilt.

### Design methods used

**Slab strengthening – the Hilti method** was used for shear friction overlay application.

### Total solution & benefits

**Design & engineering Support** by the Hilti team

**Productivity:** Planned faster factory production was made possible due to the kind of solution executed.

Cost savings of around €700,000 for the client were realized.

**Hardware:** Hilti shear connectors HCC-K 10x200 mm.

Hilti HIT-RE 500 was used as the adhesive mortars.

Hilti TE-C3X Drill bits were used for faster and efficient drilling of holes in the concrete slab.



## 10.5 Renovation of the Humboldt Bridge in Potsdam, Germany

Renovation and refurbishment of the superstructure and substructure as well as conversion of the Humboldt Bridge and its associated building was carried out. The planning and design were done by engineering specialists, Martin Krone, Berlin. The work was completed in 2007.

### Problem statement & objective

The Humboldt Bridge located in Potsdam, Germany was used both by road vehicles and trams. The renovation of the bridge and abutments were executed as a modernization procedure, thus requiring the relocation of the tram line. This was achieved by the strengthening of the box-girders of the bridge using shear connectors and the abutment structure was strengthened using post-installed rebars (see Fig. 10.10).



a) The bridge to be restored



b) Bridge box-girder strengthening with HCC-K shear connectors



c) Abutment structure with post-installed rebars

Fig. 10.10: Renovation of Humboldt Bridge in Potsdam, Germany



### Approach followed (design & solution)

- Modernization of the existing bridge was to be carried out due to updated code requirements.
- Together with Hilti and the general contractor, the engineering office developed the procedure for the design and execution of the strengthening of the bridge structure.
- The project team employed the use of coherent, coordinated systems with building authority for approval.
- The bridge was strengthened in the area of the box-girders by adding concrete shear-friction overlays using Hilti HCC-K shear connectors (see Fig. 10.10b)
- The abutment structures were strengthened by subsequent reinforcement connections using the Hilti post-installed rebar system (see Fig. 10.10c).

### Design methods used

**Bridge box girder strengthening – Hilti Method** was used for shear friction overlay application.

**Abutment structure** – Post-installed rebars for abutment structure following the national reinforced concrete standard.

### Total solution & benefits

**Design and engineering Support** by Hilti

**Hardware:** Hilti shear connectors HCC-K 10x120 mm and HCC-K 10x180 mm; Hilti HIT-RE 500 was used as the adhesive mortar.

**Trainings:** Quality assurance through training for the assembly personnel on the construction site.

## AUTHORS

### Kumaraguru Selvakumarasami



Kumaraguru Selvakumarasami obtained his MS in Civil Engineering at the Indian Institute of Technology Madras (India) with his thesis on retrofitting of structural members using advanced composites. He worked as a structural design engineer for 3 years dealing with steel and concrete building structures, after which he worked as a construction quality manager for 2 years at project jobsites in India. He is currently a Technical Manager for Engineering Content at Hilti. His field of interest includes retrofitting of structures, parametric engineering, and design of tall buildings.

### Giovacchino Genesisio



Giovacchino Genesisio graduated in structural engineering at the University of Florence (Italy) and obtained his PhD at the University of Stuttgart (Germany) on seismic assessment and retrofitting of reinforced concrete structures. He worked as a consultant for 5 years dealing with qualification, design, training, and quality inspection of fastening systems. He is currently Group Manager for Engineering Content at Hilti. His field of interest includes concrete to concrete connections, seismic retrofitting and fastening technology. He is author or co-author of several scientific publications on these topics.

## ACKNOWLEDGEMENT

The authors acknowledge the contribution of the following people in the Hilti world in creating this handbook for concrete-to-concrete connections. The below included list is and cannot be complete, because several people have contributed in various ways:

### Content

Philipp Grosser, Laura Giulietti, Amol Singh, Daphne Rocha, Daniel Ruiz, Marsal Jordi, Riccardo Figoli, Robbi Gian-Fadri, Mareike Engel, Simon, Ruenmele, Coleman O'Toole, Debora Nikolaeva-Vasileva, Sergio-Miguel Saraiva-Rodrigues, Ezequiel Abachian, Hugo Batista, Lars Taenzer, Marien Adema, Jessica Dierker, Sumit Aryan, Priyanka Kothari, Vivek Krishnan, Abu Shibily, Mariia Gavrilina, Jens Pofahl, Deepesh Seth, Anita Negele, Jandre Van Zyl, Jörg Appl, Julia von der Warth, Praveen Mishra, Pratyansh Kumar Acharya, Arun Kumar C.A., Parshant Sharma

### Reference Projects & Pictures

Divyansh Sharma, Raymond Chong, Thomas Luetzow, Gautam Dhyani, Eleonora Salerno

## REFERENCES

- [1] EN 1992-1-1:2004-12: Eurocode 2 - Design of concrete structures - Part 1-1: General rules and rules for buildings, Brussels: CEN, 2004.
- [2] EOTA TR 069: Design method for anchorage of post-installed reinforcing bars (rebars) with improved bond-splitting behaviour as compared to EN 1992-1-1, Brussels: EOTA, 2021.
- [3] EN 1992-4:2018: Eurocode 2 - Design of concrete structures - Part 4: Design of fastenings for use in concrete, Brussels: CEN, 2018.
- [4] EOTA TR 066: Design and requirements for construction works of post-installed shear connection for two concrete layers, Brussels: EOTA, 2022.
- [5] H. Spieth, Tragverhalten und Bemessung von eingemörtelten Bewehrungsstäben (Behaviour and design of post-installed reinforcing bars), in German, Stuttgart: IWB, Universität Stuttgart, 2002.
- [6] I. Simons, Verbundverhalten von eingemörtelten Bewehrungsstäben unter zyklischer Beanspruchung (Bond behavior of post-installed reinforcing bars subjected to cyclic loading), in German, Stuttgart: IWB, University of Stuttgart, 2007.
- [7] EOTA EAD 330087-01-0601: Systems for post-installed rebar connections with mortar, Brussels: EOTA, December 2020.
- [8] EN 1992-1-2: 2004: Eurocode 2: Design of concrete structures – Part 1-2: General rules – Structural fire design, Brussels: CEN, 2004.
- [9] EN 1998-1:2004: Eurocode 8: Design of structures for earthquake resistance - Part 1: General rules, seismic actions and rules for buildings, Brussels: CEN, 2004.
- [10] EOTA EAD 332402-00-0601: Post-Installed Reinforcing Bar (Rebar) Connections with Improved Bond-Splitting Behaviour Under Static Loading, Brussels: EOTA, October 2019 (pending for citation in OJEU).
- [11] EOTA EAD 332402-00-0601-v01: Post-installed reinforcing bar (Rebar) connections with improved bond-splitting behaviour under static loading: 100 years working life, Brussels: EOTA, August 2020 (pending for citation in OJEU).
- [12] EOTA EAD 332402-00-0601-v02: Post-installed reinforcing bar (Rebar) connections with improved bond-splitting behaviour under static loading and seismic action, Brussels: EOTA, November 2021 (Pending for citation in OJEU).
- [13] EOTA TR 023: Assessment of post-installed rebar connections, Brussels: EOTA, 2006.
- [14] N. Pinoteau, J. Heck, P. Rivillon, R. Avenel, P. Pimienta, T. Guillet und S. Remond, „Prediction of failure of a cantilever–wall connection using post-installed rebars under thermal loading,“ *Engineering Structures*, Bd. 56, p. 607–1619, 2013.
- [15] G. Genesio, R. Piccinin und J. Silva, „Qualification of a system for post-installed reinforcing bars under the rules established by EOTA and ICC-ES,“ in *3rd International Symposium on Connections between Steel and Concrete, September 27-29, 2017, Stuttgart, Germany, 2017*.

- [16] G. Genesio, R. Piccinin und S. Nerbano, „Seismic Assessment of Post-Installed Reinforcing Bars with Mortar Based on the European Organization of Technical Assessment,“ in *Workshop on the New Boundaries of Structural Concrete, September 19-20, 2019, Milan, Italy, 2019*.
- [17] EN 1504-6:2006 - Products and systems for the protection and repair of concrete structures –, Brussels: CEN, 2006.
- [18] EN 1766 Products and systems for the protection and repair of concrete structures - Test methods - Reference concretes for testing, Brussels: CEN, 2017.
- [19] V. Mahadik., A. Sharma und J. Hofmann, „Cast-in and post-installed rebar anchorage systems in RC column foundation joints,“ *Engineering structures*, Bd. 238, 2021.
- [20] J. Rex, A. Sharma und J. Hofmann, „A new test specimen to investigate the bond behavior of post-installed reinforcing bars,“ *Structural Concrete*, Bd. 20, Nr. 2, pp. 583-596, 2019.
- [21] V. Mahadik, Post installed rebar end anchorages in reinforced concrete structural connections (PhD Thesis), Stuttgart: Institute of Construction Materials, University of Stuttgart, 2022.
- [22] V. Mahadik, A. Sharma und J. Hofmann, „Cast-in and post-installed rebar anchorage systems in RC column foundation joints: System specific assessment and design,“ *Engineering Structures*, Bd. 276, pp. 1-25, 2023.
- [23] EOTA EAD 332347-00-0601: Connector for strengthening of existing concrete structures by concrete overlay, Brussels: EOTA, March 2021.
- [24] EOTA EAD 332347-00-0601-v01: Variant: Connector for strengthening of existing concrete structures by concrete overlay: behavior under seismic action, Brussels: EOTA, Pending for citation in OJEU.
- [25] EOTA EAD 330499-01-0601: Bonded fasteners for use in concrete, Brussels: EOTA, December 2018.
- [26] EAD 330232-01-0601: Mechanical fasteners for use in concrete, Brussels: EOTA, December 2019.
- [27] EN 206:2013+A1:2016: Concrete - Specification, performance, production and conformity, Brussels: CEN, 2013.
- [28] EN 10080:2005: Steel for the reinforcement of concrete - Weldable reinforcing steel - General, Brussels: CEN, 2005.
- [29] ETA-11/0390: Post installed rebar connections diameter 8 to 25mm made with Hilti HIT-CT 1 injection mortar, Champs-sur-Marne: CSTB, 16.10.2019.
- [30] ETA-19/0600: Injection system Hilti HY 200-R V3 for rebar connections, Berlin: DIBt, 01.06.2022.
- [31] ETA-20/0540: Post installed rebar connections diameter 8 to 40 mm made with Hilti HIT-RE 500 V4 injection mortar for a service life of 100 years, Champs-sur-Marne: CSTB, 27.11.2020.
- [32] ETA-21/0624: Post installed rebar connections diameter 8 to 40 mm made with Hilti HIT-FP 700 R injection mortar for a working life of 100 years, under static and seismic loading, Champs-sur-Marne: CSTB, 16.12.2022.
- [33] H. Kupfer, F. Münger, J. Kunz und A. Jähring, „Nachträglich verankerte gerade Bewehrungsstäbe bei Rahmenknoten (Post-Installed Straight Rebars for Frame Nodes), in German,“ *Bauingenieur*, Bd. 78, pp. 24-38, 2003. fib Model Code 2010, Lausanne, 2013.

- [34] B. S. Hamad., R. Al Hammoud und J. Kunz, „Evaluation of Bond Strength of Bonded-In or Post-Installed Reinforcement,“ *ACI Structural Journal*, Nr. March-April, pp. 207-218, 2006.
- [35] fib Model Code 2010, Lausanne, 2013.
- [36] fib Bulletin 72: Bond and anchorage of embedded reinforcement: Background to the fib Model Code for concrete structures 2010, Lausanne, 2014.
- [37] ETA-20/0539: Post-installed reinforcing bar (Rebar) connections with improved bond-splitting behaviour under static loading and seismic action for a working life of 100 years, Champs-sur-Marne: CSTB, 05.07.2022.
- [38] DIN EN 1992-1-1/NA: National Annex – Nationally determined parameters – Eurocode 2: Design of concrete structures – Part 1–1: General rules and rules for buildings, Berlin: DIN, 2013.
- [39] N. Randl, „Design recommendations for interface shear transfer in fib Model Code 2010,“ *Structural Concrete*, Bd. 3, Nr. 14, pp. 230-241, 2013.
- [40] J. Heinrich, T. Zenk und R. Maurer, „Bewehrte Beton-Beton-Verbundfugen bei nachträglicher Verstärkung: statische Tragfähigkeit (Reinforced concrete-to-concrete interfaces in case of post-installed strengthening: static resistance, in German),“ *Bauingenieur*, Bd. 94, Nr. 11, pp. 425-435, 2019.
- [41] Bewehren von Stahlbetontragwerken nach DIN EN 1992-1-1:2011-01 in Verbindung mit DIN EN 1992-1-1/NA:2011-01, Arbeitsblätter, Arbeitsblatt 11: Unterstützungen für die obere Bewehrung (in German), Duesseldorf: INSTITUT FÜR STAHLBETONBEWEHRUNG e.V., 2002.
- [42] EN 1992-2: Eurocode 2 - Design of concrete structures - Concrete bridges - Design and detailing rules, Brussels: CEN, 2005.
- [43] J. Heinrich, T. Zenk und R. Mauerer, „Bewehrte Beton-Beton-Verbundfugen bei nachträglicher Verstärkung: Ermüdungsbeanspruchung (Reinforced concrete-to-concrete interfaces in case of post-installed strengthening: fatigue action, in German),“ *Bauingenieur*, Bd. 95, Nr. 4, pp. 115-125, 2020.
- [44] V. Palieraki, E. Vintzileou und J. F. Silva, „Behavior of RC interfaces subjected to shear: State-of-the-art review,“ *Construction and Building Materials*, 2021.
- [45] V. Palieraki, E. Vintzileou und J. F. Silva, „Interface Shear Strength under Monotonic and Cyclic Loading,“ *ACI Structural journal*, Bd. 119, Nr. 3, pp. 17-28, 2022.
- [46] ETA-18/1022: Connector Hilti HCC-B with injection mortar Hilti HIT-RE 500 V3 and Hilti HIT-RE 500 V4, Berlin: DIBt, 05.05.2023.
- [47] ETA-21/0969: Connector for Strengthening of existing concrete Hilti HUS4-H, Berlin: DIBt, 16.05.2022.
- [48] ETA-20/0541: Injection system Hilti HIT-RE 500 V4, Bonded fastener with threaded rods, rebar, internally threaded sleeve HIS-(R)N and Hilti Tension anchor HZA(-R) for use in concrete for a working life of 50 and 100 years, Champs-sur-marne: CSTB, 09.06.2023.
- [49] J. Silva, „Overhead Installation of Injection-Type Adhesive Anchors - An evaluation of two available methods and recommendations for ACI's installer,“ *Concrete International*, pp. 40-49, July 2016.
- [50] EN 13036-2:2010: Road and airfield surface characteristic - Test methods: part 1: Measurement of pavement surface macrotexture depth using volumetric patch technique, Brussels: CEN, 2010.

- [51] RVS 15.02.34: Bemessung und Ausführung von Aufebton auf Fahrbahnplatten (Dimensioning and calculation aid design and detailing of concrete overlays), in German, Vienna: Österreichische Forschungsgesellschaft Strasse - Schiene - Verkehr (Austrian research association Roads - Railways - Traffic), 2011.
- [52] W. Fuchs und J. Hofmann, „Post-installed reinforcing bars – Requirements for their reliable use,“ *Developments in the Built Environment*, Bd. 5, 2021.
- [53] J. Hofmann, V. Mahadik und A. Sharma, „Assessment framework in background of TR069,“ in *5th Int. Conference Bond in Concrete, July 25-27*, Stuttgart, Germany, 2022.
- [54] EN 12350-5:2009: Testing fresh concrete - Part 5: Flow table test, Brussels: CEN, 2009.
- [55] ISO 834-1: Fire-resistance tests - Elements of building construction, Part 1: general requirements, Geneva: Switzerland, 1999.





Hilti Aktiengesellschaft  
9494 Schaan, Liechtenstein  
P +423-234 2965

[www.facebook.com/hiltigroup](http://www.facebook.com/hiltigroup)  
[www.hilti.group](http://www.hilti.group)